

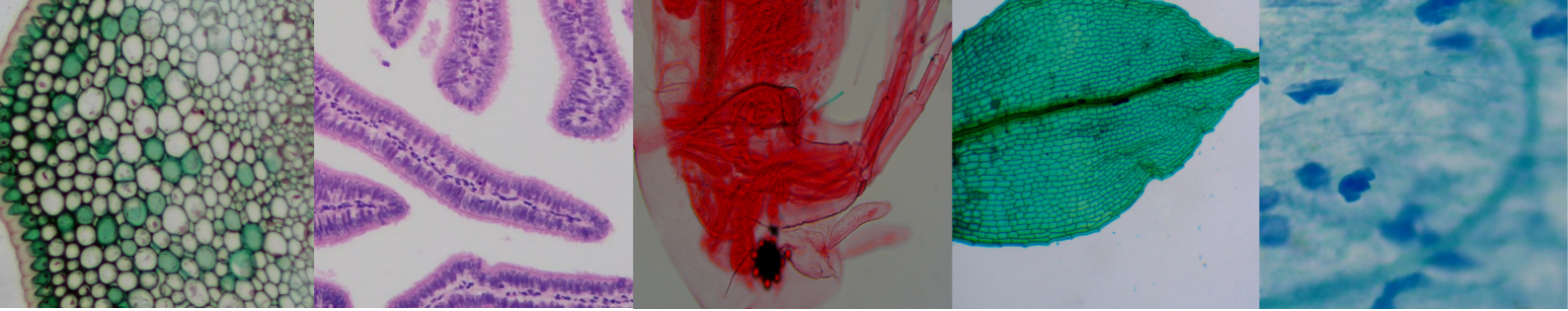

Microscopes

DUTCH OPTICAL SOLUTIONS





Your BMS Microscopes Complete Package

We provide a wide range of different types of microscopes and accessories that are suitable for professional use as well as microscopes suitable for hobbyists. The microscopes can be used for educational, industry and research purposes.

Compound Microscopes



Stereo Microscopes



Digital Microscopes



The History and Importance of Microscopes

The Dutch scientist Antoni van Leeuwenhoek is the inventor of the very first practical microscope. He contributed greatly to the history of microscopes because he has revealed a whole new dimension for the scientists. For this reason he is also known as 'the father of microscopy'.

"Without microscope we will not make any further progress."

Before, the smallest part mankind could see was as wide as a human hair. The advent of the microscopes opened suddenly a whole new world of living things in our water, in our food and around us. Scientists were able to study the existence of the micro organisms. They were able to see the smallest parts of plants, animals and the structure of cells.

Today, the microscope is not only important in biology, but is also indispensable for the laboratory studies. Moreover, it's a commonly used tool to identify problems and diseases in hospitals and clinics all over the world.

In the past centuries the Dutch scientists concerned themselves with the development of microscopes. That tradition continued to exist in the Dutch science culture ever since. At present, we can say with pride that we have achieved our goals! By the fast-growing technology, we can assure our clients that we supply the highest-quality microscopes ever.

BMS Microscopes makes your Microworld complete

from Digital Cameras



to Illumination



Even for the juniors we have solutions which allow them to explore the world



HOW TO ORDER

Step 1: Select product(s) from this catalogue

Step 2: Order easily in one of the three ways:



ONLINE

www.bmsmicroscopes.com

Placing an order through the webshop is the fastest & most convenient way to order.

First of all you will save time and most importantly you can see your prices (inclusive your discount) directly, after login.

BY PHONE

+ 31 10 458 42 22

If you would like to place an order by phone or email, please ensure that your order contains the following information:

- Your order number, contact name, telephone number, shipping address and your VAT number
- If you are placing an order on the basis of a specific quotation, please advise us on our quotation reference no.

BY EMAIL

info@bmsmicroscopes.com

HEAD OFFICE

BMS Microscopes b.v.
Essebaan 50
2908 LK Capelle aan den IJssel
The Netherlands

CC number 64035557
VAT number NL855495777B01

SALES OFFICE HOURS

Monday to Thursday
08:00 am to 16:30 pm

Friday
08:00 am to 14:30 pm

Saturday and Sunday
Closed

PAYMENT METHODS

We accept the following:

- iDeal
- Mastercards
- VISA
- Maestro
- Bancontact
- On account

Please note:

- Images used in the catalogue are for graphical representation only; actual products may vary from those shown.
- Accessories used to illustrate the use of main items are not always supplied automatically. If in doubt, please ask.
- All prices in EUROS excluding transport and VAT.
- On all technical devices BMS Microscopes gives a 5 (five) full years guarantee. If a product within the warranty period does not function or no longer functions properly, the customer must report this as soon as possible in writing to BMS Microscopes. To return the product itself, it must await the return instructions from BMS Microscopes.

For more info about the sales conditions please go to: http://extern.bmsmicroscopes.com/Terms&conditions_BMS.html

Compound Microscopes

Pages 06 - 35



Stereo Microscopes

Pages 36 - 47



Digital Cameras

Pages 48 - 59



Digital Microscopes

Pages 60 - 63



Illumination

Pages 64 - 65



BMS Dissection

Pages 66 - 75



Primary

Pages 76 - 79



Compound Microscopes Overview

BASIC MICROSCOPES



MS-2



3-AF



036 LED basic



036 LED



037 LED



037 LED Pro



037 LED Pro bino

STUDENT 100 FL SERIES



100 FL LED



200 FL LED

ADVANCED PLUS 146 SERIES



145 FL



146 FLAsQ



146 FLArQ mono



146 FLArQ bino



146 FLArQ trino

COLLEGE EDULED SERIES



EduLed FLQ



EduLed FLArQ mono



EduLed FLArQ bino



EduLed FLArQ trino

BIOLOGICAL PLUS D2-SERIES



BMS D2-211SP



BMS D2-211SP



BMS D2-211SP



BMS D2-220SP



BMS D2-220SP



BMS D2-220SP



BMS D2-223SP



BMS D2-223SP



BMS D2-223SP

BIOLOGICAL PLUS D3-SERIES



BMS D3-220eP



BMS D3-223eP223eP



BMS D3-223eP

BIOLOGICAL SERIES



C0-211



C0-223



C1-211



C1-223



C2-220

POLARIZING MICROSCOPES



1001RMS



136 PLASQ POL



E1-223 POL SP



D1-223 POL PLAN



760205 Microscope BMS MS-2

BMS MS-2

- Eyepiece: WF 10x/18 mm
- Tube: 45° inclined
- Head: 360° rotatable, adjustable in height, stop mechanism to project slide and objective
- Focussing: coarse focussing knobs with slip clutch
- Objectives: locked on, 2x
- Stage: with 2 stage clips
- Illumination: none
- Magnification: 20x
- Including: dust cover, manual and black and white plate, Ø 60 mm

BMS 036 LED

- Eyepiece: WF 10x/18 mm
- Tube: 45° inclined
- Head: monocular, fixed
- Focussing: coarse focussing knobs
- Nosepiece: triple
- Objectives: DIN achromatic 4x, 10x and 40x (spring loaded)
- Stage: with 2 stage clips
- Disc diaphragm: six aperture disc diaphragm
- Illumination: 1 LED incident and 1 LED transmitted light; incident light only suitable for the 4x and 10x objective
- Total magnification: 40x, 100x and 400x
- Powered by: 3 AA batteries
- Package dimension: 21 x 16 x 35 cm
- Mass: 1,1 kg
- Including: dust cover, manual and batteries 3x AA



75895 Microscope BMS 036 LED Basic



75910 Microscope BMS 3-AF

BMS 3-AF

- Eyepiece: WF 10x/18 mm
- Tube: monocular
- Head: fixed
- Nosepiece: triple
- Objectives: DIN achromatic 4x (NA 0,10), 10x (NA 0,25) and 40x (NA 0,65) spring loaded
- Stage: with 2 stage clips
- Focussing: coarse & fine focussing knobs with slip clutch
- Condenser: fixed, N.A. 0,65 with disc diaphragm
- Illumination: rotatable plano and concave mirror, Ø 50 mm
- Magnification: 40x, 100x and 400x
- Stand: full size
- Package dimension: 28 x 20 x 38 cm
- Mass: 2,2 kg
- Including: dust cover, manual, tension wrench

BMS 036 LED rechargeable

- Eyepiece: WF 10x/18 mm, locked
- Tube: 45° inclined
- Head: fixed position
- Focussing: coarse focussing knobs with slip clutch and slide protection
- Nosepiece: triple
- Objectives: DIN achromatic 4x, 10x and 40x (spring loaded)
- Stage: with 2 stage clips
- Condenser: fixed, N.A. 0,65 with disc diaphragm
- Illumination: 1 LED
- Magnification: 40x, 100x and 400x
- Power supply: rechargeable batteries (3x AA batteries, for approx. 300 hours of use)
- Including: dust cover, manual, rechargeable batteries and battery charger



75925 Microscope BMS 036 LED rechargeable

BMS 037 LED

- Eyepiece: WF 10x/18 mm, locked
- Tube: 45° inclined
- Head: 360° rotatable
- Focussing mechanism: coarse focussing knobs
- Nosepiece: triple
- Objectives: DIN achromatic 4x, 10x and 40x (spring loaded)
- Stage: with 2 stage clips and slide protection
- Condenser: fixed, N.A. 0,65 with a six aperture disc diaphragm
- Illumination: 1 LED incident and 1 LED transmitted light; incident light only suitable for the 40x and 100x magnification range
- Magnification: 40x, 100x and 400x
- Power supply: 3 rechargeable AA batteries
- Including: dust cover, manual, 3 rechargeable AA batteries and adapter with charge indicator

BMS 037 LED Pro

- Eyepiece: WF 10x/18 mm, locked
- Tube: monocular 45° inclined
- Head: 360° rotatable
- Focussing mechanism: coaxial coarse and fine focussing knobs
- Nosepiece: quadruple
- Objectives: DIN achromatic 4x, 10x, 40x (spring loaded) and 100x (oil immersion, spring loaded)
- Mechanical stage: built-in
- Condenser: spiral, Abbe N.A. 1,25
- Illumination: 1 LED incident and 1 LED transmitted light; incident light only suitable for the 40x and 100x magnification range
- Magnification: 40x, 100x, 400x and 1000x
- Power supply: 3 rechargeable AA batteries
- Including: dust cover, manual, 3 rechargeable AA batteries 1300 mA and adapter with charge indicator

Basic Accessories

75957 Starter kit BMS microscopes

- 5 prepared slides
- 5 plain slides
- Cover glass
- Forceps
- Bottle of red liquid
- Bottle of blue liquid
- Plastic dropper
- Needle
- Cotton stick
- Wooden stick
- Test tube
- Approx. 50 sheets of optical lens paper



75946 Digital head 1,3 megapixels

- Replaces the standard head of model 037
- Comes complete with 45° tube, however without eyepiece
- Including: software BMS_pix



29554 Battery rechargeable, 3 pcs.

- Voltage: 1.2 V
- Type: HR6 nickel metal hydride, AA battery
- Dimensions: 50 x Ø 14 mm
- Capacity: 1300 mAh



76082 Charger EURO for BMS 4,5 V DC/ 1 A

- Can be used for 4,5 V and 4,6 V systems
- Input: 100 - 240 V AC/ 50/60 Hz
- Output: 4,5 V DC, 1000 mA
- EURO version (UK version 760825)

Item no.	Description
76530	Universal Digitube adapter
76531	Smartphone holder for Digitube
75925.3	Battery rechargeable 4,6 V for BMS 036
75936	Barlow adapter voor BMS 036
75934	Microscope storage case for BMS 036, aluminum
76033	Carrying case for BMS microscopes
75921	Illuminator for BMS 3 series detachable LED with power plug
75920	Illuminator 230 V/ 15 W for BMS 3 series detachable EURO
75922	Illuminator 230 V/ 15 W for BMS 3 series detachable UK
75935	Eyepiece WF 16x for BMS 036
76083	Charger UK for BMS 4,5 V DC/ 1 A
760825	Charger EURO for BMS 7,5 V DC/ 1 A
760835	Charger UK for BMS 7,5 V DC/ 1 A
76026	Microscope maintenance kit
15543	Lens tissues
77092	Immersion oil, 5 ml



76052 Mirror without base

- For BMS 2 and BMS 100
- Diameter: 42 mm



75938 BMS 037 LED



75939 BMS 037 LED Pro



75940 BMS 037 LED Pro binocular

BMS 100 FL LED



- Optical System: finite optical system, 160 mm
- Eyepiece: WF 10x/18 mm with pointer, locked
- Head: monocular, 360° rotatable
- Tube: 45° inclined
- Anti-bacterial paint: yes
- Anti-fungus optics: yes
- Nosepiece: triple revolving nosepiece with click stops
- Objectives: DIN achromatic 4x/0.10, 10x/0.25 and 40x/0.65 (spring loaded)
- Focussing mechanism: coarse with slip clutch and fine focussing knobs with slide protection
- Fine focus precision: 2 µm minimum increment
- Stage: 110 x 120 mm metal plan stage with 2 stage clips and one finger touch lift
- Stage limit stop: preset and adjustable
- Condenser: fixed, N.A. 0.65 with built-in iris diaphragm and filter holder
- Magnification: 40x, 100x and 400x. Optional extendable up to 1500x.
- Power: 100~230 V/50 Hz
- Lifespan LED: approx. 50.000 hours
- Illumination: new generation High Power LED. Light intensity stepless adjustable through rotary potentiometer.
- Double electrical safety: separation from the main power through DPDT* switch
- With indicator LED on the back to show if main power is switched on and if optional battery is charged
- Multi power use: yes (main power cable, rechargeable batteries, non rechargeable batteries)
- Cordless use: 3 hours charging time and 10 hours cordless working time (with optional rechargeable batteries)
- Detachable IEC power cord: C13 connector (connecting to the microscope) to Schuko (available for EU and UK)
- Including: dust cover, manual and tension wrench

2760611 Microscope BMS 100 FL LED

BMS 200 FL LED

- Eyepiece: WF 10x/18 mm with pointer, locked
- Tubes: first tube 45° inclined with eyepiece, second tube 90° without eyepiece
- Nosepiece: triple
- Objectives: DIN achromatic 4x, 10x and 40x
- Focussing mechanism: coarse with slip clutch and fine focussing knobs with slide protection
- Stage: 110 x 120 mm metal plan stage with 2 stage clips
- Condenser: fixed, N.A. 0.65 with built-in iris diaphragm and filter holder
- Illumination: new generation power LED
- Lifespan: approx. 50.000 hours
- Magnification: 40x, 100x and 400x. Optional extendable up to 1500x.
- Power supply: 90~240 V / 50 Hz
- Detachable power cord
- Including: dust cover, manual and tension wrench



760155 Microscope BMS 200 FL LED



2760611 Microscope BMS 100 FL LED



76063 Head dual view BMS 100 FL 1x 45° & 1x 90°



760155 Microscope BMS 200 FL LED



766603100AK1 Camera, USB2.0, CMOS 3 MP kit 90



760235 Microscope BMS 100-FL-Digi 3 MP

*FUN FACT:
EASY & QUICKLY
TO BE UPGRADED
TO OTHER VERSIONS*

100-series Accessories



76063 Head dual view BMS 100 FL 1x 45° & 1x 90°

Upgrade your BMS 100 FL (2760611) with a dual head. The delivery is a new head and allen key to mount the dual head. You can use the eyepiece WF 10x of the standard head. The 90° tube is standard without eyepiece for easy mounting the camera.



76043 Objective 100x BMS, achr., N.A. 1,25, spring loaded and oil immersion



76047 Eyepiece WF 15x

• Diameter: 23,2 mm

Item no.	Description
760605	Photo adapter DSLR universal
76530	Universal Digitube adapter
76531	Smartphone holder for Digitube
738910	Dark field ring
76071	Polarization set for BMS compound
29554	Battery rechargeable, 3 pcs.
76055	Spare bulb 230 V/25 W, BA 15
76052	Mirror without base
76035	Movable specimen holder for BMS 2/100/200
76036	Movable specimen holder, universal
76050	Stage clip for BMS 100, 145, 146 and EduLed
76040	Objective 4x, DIN achromatic
76041	Objective 10x, DIN achromatic
76042	Objective 40x, achromatic
76038	Objective 60x, DIN achromatic
76051	Nosepiece quadruple for BMS 2/100/200
76010.07	Head BMS 100 FL without eyepiece WF 10x
76045	Eyepiece H 5x
76044	Eyepiece H 10x
76046	Eyepiece WF 10x with pointer
760465	Eyepiece WF 10x without pointer
77042	Micrometer eyepiece WF 10x/18 mm
77081	Eyepiece micrometer
77090	Stage micrometer graticule 1 mm in 0,01 mm
76053	Blue filter, 32 mm
76010.02	Irisdiaphragm
76010.01	Irisdiaphragm
760766	Charger EURO for BMS 6 V DC/ 500 mA
760825	Charger EURO for BMS 7,5 V DC/ 1 A
760835	Charger UK for BMS 7,5 V DC/ 1 A
76995	Power cord with EURO plug
76999	Power cord with UK plug
76998	Power cord with CH plug
748248	Tube cap to cover the tube
7605101	Screw cap for objective hole
75957	Starter kit BMS microscopes
76026	Microscope maintenance kit
15543	Lens tissues
77092	Immersion oil, 5 ml
76054	Dust cover
76033	Carrying case for BMS microscopes



Including: dust cover, manual, cable 100...240 V, blue filter and tension key

Compound Advanced Plus Microscopes

BMS 146-series microscopes	145 FL	146 FLAsQ	146 FLArQ mono	146 FLArQ bino	146 FLArQ trino
Article code	4748885	4748905	4748910	4748915	4748920
Eyepiece: WF 10x/18 mm	✓	✓	✓	✓	✓
Head: monocular 360° rotatable	✓	✓	✓		
Head: binocular 360° rotatable				✓	
Head: trinocular 360° rotatable					✓
Triple revolving nosepiece	✓				
Quadruple revolving nosepiece		✓	✓	✓	✓
Objectives 4x, 10 and 40x	✓	✓	✓	✓	✓
Magnification: optional extendable up to 1500x	✓	✓	✓	✓	✓
DIN achromatic	✓	✓	✓	✓	✓
Focussing: coarse & fine focus controls	✓				
Focussing: dual coaxial coarse & fine focus controls		✓	✓	✓	✓
Integrated XY mechanical stage			✓	✓	✓
Condenser: fixed N.A. 0.65	✓				
Condenser: Abbe N.A. 1.25		✓	✓	✓	✓
High power LED	✓	✓	✓	✓	✓
Main power cable or rechargeable batteries or non rechargeable batteries	✓	✓	✓	✓	✓



146-series Accessories



4748915 BMS146 FLArQ bino



4748920 BMS146 FLArQ trino

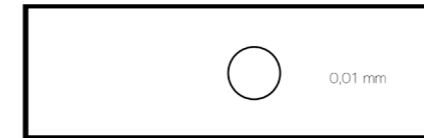

77090 Stage micrometer graticule 1 mm in 0.01 mm



77092 Immersion oil, 5 ml



748965 Head dual view BMS 146 1x 90° & 1x 45°

Item no.	Description
77042	Micrometer eyepiece WF 10x/18 mm
760605	Photo adapter DSLR universal
76530	Universal Digitube adapter
76531	Smartphone holder for Digitube
748975	Digital head 3 megapixels
738910	Dark field ring
76071	Polarization set for BMS compound
29554	Battery rechargeable, 3 pcs
76040	Objective 4x, DIN achromatic
76041	Objective 10x, DIN achromatic
76042	Objective 40x, DIN achromatic
738890	Objective 60x, DIN achromatic Semi Plan N.A. 0,85
738893	Objective 100x, DIN achromatic Semi Plan N.A. 1,25
748960	Head mono BMS 146
748961	Head bino BMS 146
748963	Head trino BMS 146
76046	Eyepiece WF 10x with pointer
760465	Eyepiece WF 10x without pointer
76047	Eyepiece WF 15x
76053	Blue filter, 32 mm
76995	Power cord with EURO plug
76999	Power cord with UK plug
76998	Power cord with CH plug
748248	Tube cap to cover the tube
75957	Starter kit BMS microscopes
76026	Microscope maintenance kit
15543	Lens tissues
76054	Dust cover
76033	Carrying case for BMS microscopes

Compound College Microscopes

EduLed microscopes	EduLed FLQ	EduLed FLArQ mono	EduLed FLArQ bino	EduLed FLArQ trino
Article code	5738860	5738870	5738875	5738880
Eyepiece: WF 10x/18 mm Extra large	✓	✓	✓	✓
Head: monocular, 360° rotatable	✓	✓		
Head: binocular, 360° rotatable			✓	
Head: trinocular, 360° rotatable				✓
Quadruple revolving nosepiece	✓	✓	✓	✓
Objectives 4x, 10x and 40x	✓	✓	✓	✓
Magnification: optional extendable up to 1000x	✓	✓	✓	✓
DIN achromatic Semi Plan	✓	✓	✓	✓
Focussing: dual coaxial coarse & fine focus controls	✓	✓	✓	✓
Integrated XY mechanical stage		✓	✓	✓
Condenser: fixed N.A. 0.65	✓			
Condenser: Abbe N.A. 1.25		✓	✓	✓
High power LED	✓	✓	✓	✓
Integrated handle for easy transport	✓	✓	✓	✓
Main power cable or rechargeable batteries or non rechargeable batteries	✓	✓	✓	✓



5738860 BMS EduLed FLQ



5738870 BMS EduLed FLArQ mono



5738875 BMS EduLed FLArQ bino



5738880 BMS EduLed FLArQ trino

EduLed Accessories



76530 Universal Digitube adapter

- Suitable eyepiece size: 28 ~ 45 mm (Ø)
- Platform load: max. 2.0 kg
- Materials: ABS, alloy of aluminum
- Height: 195 mm
- Weight: 350 g

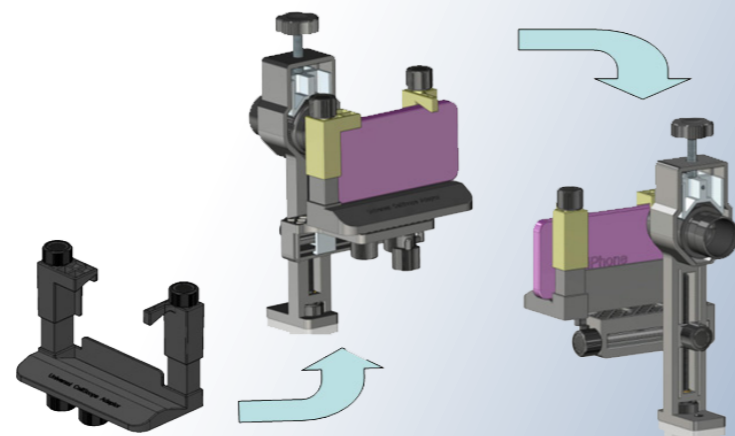

76531 Smartphone holder for Digitube

Upgrade your Digitube adapter with this special phone holder and take pictures right away with your smartphone.

- Materials: ABS, alloy of aluminum
- Weight: 100 g



*FUN FACT:
TAKE PERFECT
PICTURES WITH YOUR
OWN SMARTPHONE.*

*ALL YOU NEED IS A BMS
MICROSCOPE + UNIVERSAL
DIGITUBE ADAPTER (76530)
+ SMARTPHONE HOLDER FOR
DIGITUBE (76531).*



738635 Head dual view BMS EduLed
1x 45° & 1x 90°



738633 Microscope head with 3 megapixel camera for
BMS EduLed

Item no.	Description
760605	Photo adapter DSLR universal
738910	Dark field ring
738645	Polarization set BMS EduLed
76071	Polarization set for BMS compound
29554	Battery rechargeable, 3 pcs
738887	Objective 4x, DIN achromatic Semi Plan N.A. 0,10
738888	Objective 10x, DIN achromatic Semi Plan N.A. 0,25
738889	Objective 40x, DIN achromatic Semi Plan N.A. 0,65
738890	Objective 60x, DIN achromatic Semi Plan N.A. 0,85
738893	Objective 100x, DIN achromatic Semi Plan N.A. 1,25
738634	Head mono BMS EduLed
738636	Head bino BMS EduLed
738638	Head trino BMS EduLed
738640	Eyepiece WF 10x with pointer BMS EduLed
738642	Eyepiece WF 10x without pointer BMS EduLed
738643	Micrometer eyepiece WF 10x for BMS EduLed
77042	Micrometer eyepiece WF 10x/18 mm
77090	Stage micrometer graticule 1 mm in 0,01 mm
738896	Rubber eye cap for BMS EduLed
760825	Charger EURO for BMS 7,5 V DC/1 A
760835	Charger UK for BMS 7,5 V DC/1 A
76995	Power cord with EURO plug
76999	Power cord with UK plug
76998	Power cord with CH plug
738895	Spare LED for EduLed
7605101	Screw cap for objective hole
748248	Tube cap to cover the tube
75957	Starter kit BMS microscopes
76026	Microscope maintenance kit
15543	Lens tissues
77092	Immersion oil, 5 ml
76054	Dust cover

Compound Biological Plus Microscopes BMS D2

BMS D2 microscopes	BMS D2-211SP 400x	BMS D2-211SP 600X	BMS D2-211SP 1000X	BMS D2-220SP 400x	BMS D2-220SP 600X	BMS D2-220SP 1000X	BMS D2-223SP 400x	BMS D2-223SP 600X	BMS D2-223SP 1000X
Article code	8746110	8746110-60	8746110-100	8746120	8746120-60	8746120-100	8746130	8746130-60	8746130-100
Eyepiece: WFP 10x/20 mm with foldable eyecups	✓	✓	✓	✓	✓	✓	✓	✓	✓
Tube: 30° inclined, 160 mm tube length	✓	✓	✓						
Tube: 45° inclined, 160 mm tube length				✓	✓	✓			
Tube: 45° inclined, 160 mm tube length. Extra tube 90° for photo and/or video use.							✓	✓	✓
Head: monocular, binocular or trinocular 360° rotatable	Monocular	Monocular	Monocular	Binocular	Binocular	Binocular	Trinocular	Trinocular	Trinocular
Nosepiece: quadruple, ball bearing type with rubber grip	✓	✓	✓	✓	✓	✓	✓	✓	✓
Objectives: DIN sPlan High Resolution, 4x (N.A. 0.10), 10x (N.A. 0.25), 40x (N.A. 0.65). The 40x objective is spring loaded	✓		✓	✓			✓		
Objectives: DIN sPlan High Resolution, 4x (N.A. 0.10), 10x (N.A. 0.25), 40x (N.A. 0.65). The 60x objective is spring loaded		✓			✓			✓	
Objectives: DIN sPlan High Resolution, 4x (N.A. 0.10), 10x (N.A. 0.25), 40x (N.A. 0.65). The 100x objective is spring loaded			✓			✓			✓
Focusing: coaxial coarse and fine Adjustment on both sides. Fine adjustment is supplied with a scale division.	✓	✓	✓	✓	✓	✓	✓	✓	✓
Stage: 140 x 155 mm, suitable for one slide. Equipped with integrated movable specimen holder with ergonomically placed coaxial controls for accurate X-Y movement.	✓	✓	✓	✓	✓	✓	✓	✓	✓
Condenser: Rack and pinion N.A. 1.25 Abbe condenser	✓	✓	✓	✓	✓	✓	✓	✓	✓
Illumination: new generation LED (3 Watt) with Köhler iris diaphragm and with life span LED approx. 50,000 hours	✓	✓	✓	✓	✓	✓	✓	✓	✓
Magnification: 40x, 100x, 400x, 600x or 1000x Optional to be extended to 2000x	40x, 100x & 400x	40x, 100x, 400x & 600x	40x, 100x, 400x & 1000x	40x, 100x & 400x	40x, 100x, 400x & 600x	40x, 100x, 400x & 1000x	40x, 100x & 400x	40x, 100x, 400x & 600x	40x, 100x, 400x & 1000x
Voltage: 100 ~ 240 V/50 Hz.	✓	✓	✓	✓	✓	✓	✓	✓	✓
Including : detachable power cord, dust cover and user manual	✓	✓	✓	✓	✓	✓	✓	✓	✓

How to choose a BMS D2 microscope in two steps:

Step 1: HEAD	Step 2: MAGNIFICATION		
	Standard*	Including 600x	Including 1000X
Monocular	8746110	8746110-60	8746110-100
Binocular	8746120	8746120-60	8746120-100
Trinocular	8746130	8746130-60	8746130-100

* Standard magnification: 40x, 100x & 400x



A new approach for higher demands in microscopy. In a nutshell: flexible, efficient, stable and comfort in use. To be used in a variety of educational, laboratory and professional environments. The BMS D2 will meet all the demands that are made in the field of these sectors.

BMS D2-series Accessories

76532 PhoneTube mobile phone adapter, universal

PhoneTube accommodates a wide range of smartphones including the larger “phablets” like the iPhone 11 Plus and latest Samsung Galaxy devices. The phone platform is fully adjustable and can fit any device—usually with the case still on. The secure platform stands up to the weight of these heavier devices with ease, thanks to PhoneTube strong metal base.

PhoneTube is compatible with binoculars- and monocular microscopes and provides you with everything you need to capture sharp, detailed images and video.



Item no.	Description
738910	Dark field ring
8746498	Polarizing kit for BMS D2
15543	Lens tissues
76026	Microscope maintenance kit
760605	Photo adapter DSLR, universal
75515	Stage temperature controlled, universal
77092	Immersion oil, 5 ml
8746492	Dark field condensor BMS d2, dry
8746495	Dark field condensor BMS d2, oil
8746471	Objective 4x, sPlan BMS D2
8746472	Objective 10x, sPlan BMS D2
8746474	Objective 20x, sPlan BMS D2
8746475	Objective 40x, sPlan BMS D2
8746477	Objective 60x, sPlan BMS D2
8746478	Objective 100x, sPlan BMS D2
8746503	Dust cover BMS D2 & D3

BMS D3 microscopes

	BMS D3-220eP with binocular head and 4 infinity objectives	BMS D3-223eP with trinocular head and Epi Fluorescence	BMS D3-223eP with trinocular head and 4 infinity objectives
Article code	9746120	9746140	9746130
Eyepieces: WFP 10x/22 mm with foldable eyecups	✓	✓	✓
Tube: 45° inclined, 160 mm tube length	✓	✓	✓
Head: binocular 360° rotatable	✓		
Head: trinocular 360° rotatable		✓	✓
Nosepiece: quintuple, ball bearing type with rubber grip	✓	✓	✓
Objectives: DIN ePlan High Resolution, 4x (N.A. 0.10), 10x (N.A. 0.25), 40x (N.A. 0.65). The 40x objective is spring loaded	✓	✓	✓
Focusing: coaxial coarse and fine adjustment on both sides. Fine adjustment is supplied with a scale division. Each division equals 0.0015 mm (0.30 mm/rotation).	✓	✓	✓
Stage: Rackless, 144 x 200 mm, suitable for two slides at one time. Equipped with integrated movable specimen holder with ergonomically placed coaxial controls for accurate X-Y movement. Range 77 x 32 mm.	✓	✓	✓
Condenser: Rack and pinion N.A. 1.25 Abbe condenser	✓	✓	✓
Illumination: new generation LED (3 Watt) with Köhler iris diaphragm and with life span LED approx. 50,000 hours	✓	✓	✓
Magnification: 40x, 100x, 400x & 1000x Optional to be extended to 2000x	✓	✓	✓
Voltage: 90 ~ 240 V/50 Hz	✓	✓	✓
Including : detachable power cord, dust cover and user manual	✓	✓	✓



BMS D3-series Accessories

Item no.	Description
9746487	Phasecontrast set 10x/20x/40x/100x, BMS D3
76532	PhoneTube mobile phone adapter, uniserial
8746503	Dust cover BMS D2 & D3

Compound Biological Microscopes

C-series microscopes	C0-211 monocular with DIN Semi Plan objectives	C0-223 trinocular with DIN Semi Plan objectives	C1-211 monocular DIN Achromatic		C1-223 trinocular DIN Achromatic	C2-220 binocular DIN Plan Achromatic	C2-220 binocular, Ergo head DIN Plan Achromatic	C2-223 trinocular DIN Plan Achromatic
Article code	739950	739970	74290		74310	74400	74405	74410
Eyepiece: WF 10x/18 mm	✓	✓	✓		✓			
Eyepiece: WF 10x/22 mm						✓	✓	✓
Tube: 30° inclined	✓	✓				✓		✓
Tube: 45° inclined			✓		✓			
Tube: 20° to 45° inclined							✓	
Head: monocular 360° rotatable	✓		✓					
Head: binocular 360° rotatable						✓	✓	
Head: trinocular 360° rotatable		✓			✓			✓
Quadruple revolving nosepiece	✓	✓	✓		✓	✓	✓	✓
DIN achromatic 4x, 10x, 40x and 100x			✓		✓			
DIN Semi Plan 4x, 10x, 40x and 100x	✓	✓						
DIN Plan achromatic 4x, 10x, 40x and 100x						✓	✓	✓
Focussing: dual coaxial coarse & fine focus controls	✓	✓	✓		✓	✓	✓	✓
Rack and pinion N.A. 1.25 Abbe condenser	✓	✓	✓		✓	✓	✓	✓
Integrated XY mechanical stage	✓	✓	✓		✓	✓	✓	✓
Illumination: 6 V/20 W halogen	✓	✓	✓		✓	✓	✓	✓
Detachable power cord	✓	✓	✓		✓	✓	✓	✓



739950 C0-211 monocular with DIN Semi Plan objectives



739970 C0-223 trinocular with DIN Semi Plan objectives



74290 C1-211 monocular with DIN Achromatic objectives



74310 C1-223 trinocular with DIN Achromatic objectives



74410 C2-223 trinocular with DIN Plan Achromatic objectives



74400 C2-220 binocular with DIN Plan Achromatic objectives 0 550,00



74405 C2-220 binocular, Ergo head, with DIN Plan Achromatic objectives

C-series Accessories

760605 Photo adapter DSLR universal

High-grade optical adapter for connecting a DSLR camera to a microscope with 23.2 mm diameter inner tube or trinocular head.

Allows you to take high resolution photos of microscope specimens.



76026 Microscope maintenance kit

With the following content:

- Screwdriver: Philips head, 1
- Screwdriver: Philips head, 2
- Precision screwdriver: Philips head: No. 0000/ 000/ 00/ 0 and 1
- Precision screwdriver: 1,0/ 1,2/ 1,4/ 1,8/ 2,4 and 3,0 mm
- Crescent shaped wrench for friction of coarse focussing
- Offset screwdriver: 1 + 2
- Allen key: 1,5 mm
- Allen key: 2 mm
- Allen key: 3 mm
- Lens paper



Item no.	Description
738910	Dark field ring
75527	Microscope storage case for E1-220/223 POL SP
74420	Eyepiece WF 15/15 mm
74440	Objective 4x for BMS C1
74445	Objective 10x for BMS C1
744485	Objective 20x, Plan infinity for BMS C1
74460	Objective 100x for BMS C1
74423	Objective 20x, ePlan infinity for BMS C2
748248	Tube cap to cover the tube
75957	Starter kit BMS microscopes
15543	Lens tissues
77092	Immersion oil, 5 ml

BMS 1001RMS

- Eyepiece: WF 10x/18 mm with pointer, locked
- Tube: 45°
- Head: 360° rotatable with switchable analyzer
- Nosepiece: quadruple
- Objectives: DIN achromatic Semi Plan 4x, 10x and 20x (spring loaded). You can opt for 40x, 60x and/or 100x.
- Focussing mechanism: coarse and fine focus controls
- Stage: with 2 stage clips
- Condenser: fixed, N.A. 0,65 with disc diaphragm
- Disc diaphragm: 3x standard holes, 1x polarizer, 1x dark field
- Illumination: LED with dimmer
- Magnification: 40x, 100x and 200x (optionally expandable: 400x, 600x and 1000x)
- Voltage: 230 V/50 Hz
- Including: dust cover, manual, power cord and tension wrench



760247 Microscope BMS 1001RMS

BMS E1-223 POL SP

- Eyepieces: WF 10x/18 mm with built-in cross line reticle
- Trinocular head: with a 55 mm - 75 mm IPD range
- Stage: the fully rotatable stage is 160 mm in diameter, has ball bearing movement, detachable stage clips, an adjustable screw stop and graduation marks every degree.
- Objectives: DIN Semi Plan 4x, 10x, 20x and 40x yielding magnification of 40x, 100x, 200x and 400x
- Condenser: N.A. 1.25 Abbe condenser with iris and swing out filter holder (included blue filter) is controllable by rack & pinion movement.
- Focussing mechanism: coaxial coarse & fine adjustment mechanism with interior steel gears for precision focus movement
- Illumination: built-in universal power supply 6 V/30 W variable halogen light source
- Included with the microscope is a quartz wedge compensator, mica compensator 1/4 wavelength, gypsum compensator one wavelength.



75525 Microscope BMS E1-220 POL SP

BMS 136 PLASQ POL Halogen

- Eyepiece: WF 10x/18 mm with pointer, locked
- Tube: 45° inclined, not rotatable
- Nosepiece: triple
- Objectives: DIN achromatic 4x, 10x and 40x (spring loaded)
- Focussing: coaxial ball bearing guideways coarse and fine focussing knobs on both sides
- Stage: rotatable, round object table with scale approx. Ø 125 mm. Provided with stage clamps for holding the specimen.
- Sub-stage condenser: rack and pinion N.A. 1.25 Abbe condenser
- Illumination: built-in, adjustable halogen illumination 12 V/ 20 W
- Magnification: 40x, 100x and 400x
- Voltage: 220~240 V/ 50 Hz
- Including: dust cover, manual, power cord and blue filter



74777 Microscope BMS 136 PLASQ POL Halogen

BMS D1-223 POL PLAN

- Eyepieces: WFP 10x/18 mm with foldable eye guards
- Tubus: 45° inclined, 160 mm mechanical tube length
- Head: trinocular, 360° rotatable
- Analyzer: pull out mechanism with graduation, mounted in head
- Nosepiece: quadruple, ball bearing type
- Objectives: DIN Plan achromatic High Resolution, 4x (N.A. 0.10), 10x (N.A. 0.25), 40x (N.A. 0.65) spring loaded (for slide protection).
- Focussing: coaxial coarse and fine adjustment on both sides
- Stage: circular, ball bearing, with graduation, can be rotated over 360°, 160 mm diameter with locking screw.
- Compensation filters: sliders. Quartz, mica 1/4 and gypsum red 1st order.
- Condenser: N.A. 1.25 Abbe condenser in holder. Adjustable in height via rack and pinion.
- Illumination: halogen (20 Watt) Köhler
- Voltage: 90 - 240 V / 50 Hz
- Including: dust cover, manual and power cord



7462355 Microscope BMS D1-223 POL PLAN

Stereo Microscopes Overview

STEREO MICROSCOPES



S-05-L



S-10-2L



S-20-2L LED (2x)



S-40-2L LED
(1x/3x)



S-40-2L LED
(2x/4x)



SL-40



ST-50

XL STEREO MICROSCOPES



130 LED



Zoom 133 LED



Zoom 133 Trino LED



11-C-2L



11-B-2L



11-B-2L Trino



140 Bino Zoom LED



143 Trino Zoom LED

Stereo Microscopes

Stereo microscopes	Stereo BMS S-05-L	Stereo BMS S-10-2L	Stereo BMS S-20-2L LED (2x)		Stereo BMS S-40-2L LED (1x/3x), 230V	Stereo BMS S-40-2L LED (2x/4x), 230V	Stereo BMS SL-40	Stereo BMS ST-50
Article code	760955	761105	6762105		6762535	6762575	76250	76251
Pole stand	✓	✓	✓		✓	✓		
Eyepiece: WF 10x/20 mm	✓	✓	✓		✓	✓	✓	✓
Tube: 45° inclined	✓		✓		✓	✓	✓	✓
Head: 360° rotatable					✓	✓		
Objective: 2x	✓		✓					
Objectives: 1x and 3x					✓			
Objectives: 2x and 4x						✓		
Objective: 1x in slide holder, exchangeable							✓	
Objective: 1x in slide holder, NOT exchangeable								✓
Objectives: 2x in slide holder, exchangeable		✓						
Focussing: coarse focussing knobs with slip clutch	✓	✓	✓		✓	✓	✓	✓
Illumination LED	✓	✓	✓		✓	✓		✓
Illumination halogen							✓	
Magnification	20x	20x	20x		10x and 30x	20x and 40x	10x	10x
Power connection: 100~230 V/50 Hz		✓	✓		✓	✓		
Power connection: 230 V/50 Hz							✓	✓
Rechargeable			✓		✓	✓		



760955 Stereo BMS S-05-L



761105 Stereo BMS S-10-2L LED (2x)



6762105 Stereo BMS S-20-2L LED (2x) 230 V



6762535 Stereo BMS S-40-2L LED (1x/3x), 230 V



6762575 Stereo BMS S-40-2L LED (2x/4x), 230 V



76250 Stereo BMS SL-40



76251 Stereo BMS ST-50 LED

Stereo's Accessories

Item no.	Description
76530	Universal Digitube adapter
76531	Smartphone holder for Digitube
29554	Battery rechargeable, 3 pcs
76162	Object holder
76166	Stage for BMS 20, 30, 40, 11 and 14x series
76471	Bulb halogen for BMS 40-B-2L/40-C-2L
76160	Spare bulb for BMS S-10/S-20/ST-30
76031	Storage case, wooden
76039	Storage case for BMS 20-/30-C-2L-/40 series, aluminum
76141	Specimen holder plate Ø 60 mm, black and white
761435	Specimen holder plate Ø 95 mm, black and white
76164	Plate Ø 60 mm, glass
76143	Plate Ø 95 mm, glass
76144	Eyepiece WF 5x/18 mm, set of two
76145	Eyepiece WF 10x/20 mm, set of two
76146	Eyepiece WF 15x/13 mm, set of two
76147	Eyepiece WF 20x/10 mm, set of two
76150	Objective holder pair 1x for BMS S-10 series
76155	Objective holder pair 2x for BMS S-10 series
76153	Objective holder pair 3x for BMS S-10 series
76158	Objective holder pair 6x for BMS S-10 series
76250.1	Objective holder pair 1x for BMS SL-40
76250.2	Objective holder pair 2x for BMS SL-40
76250.3.5	Objective holder pair 3.5x for BMS SL-40
76149	Micrometer eyepiece WF 10x/18 mm
77091	Stage micrometer graticule 10 mm in 0,1 mm
76250.7	Toplight, side and centre for BMS SL-40
76082	Charger EURO for BMS 4,5 V DC/ 1 A (UK 76083)
76026	Microscope maintenance kit
15543	Lens tissues
75687	Dust cover for BMS TS series



76161 Dark field adapter for BMS ST...-2L



75688 Specimen holder plate Ø 100 mm, black and white



76142 Plate Ø 80 mm, glass



76148 Eye caps for microscopes BMS 10/20/30/40/50



76054 Dust cover (35 cm x 39 cm)



76156 Objective holder pair 4x for BMS S-10 series



75820 Eyepiece WF25x for BMS TS series, set of two

XL Stereo Microscopes

XL Stereo microscopes	Stereo BMS 130, LED	Stereo zoom BMS 133, LED	Stereo zoom BMS 133, Trino, LED
Article code	74920	74940	74945
Eyepiece: WF 10x/22 mm	✓	✓	✓
Tube: 45° inclined	✓	✓	✓
Head: binocular 360° rotatable	✓	✓	
Head: trinocular 360° rotatable			✓
Zoom objectives: stepless adjustable 0,7x to 4,5x		✓	✓
Objectives: 1x and 3x			
Objectives: 2x and 4x	✓		
Magnification	20x and 40x	7x to 45x	7x to 45x
Focussing: coarse focussing knobs on both sides with tension control	✓	✓	✓
Height adjustment by the pole by rack & pinion	✓	✓	✓
Handle for easy carrying	✓	✓	✓
Illumination LED	✓	✓	✓
Illumination halogen			
Power connection: 230 V/ 50 Hz	✓	✓	✓
Including: dust cover, eye caps, manual, frosted glass disc and detachable power cord	✓	✓	✓
Including: dust cover, eye caps, manual, Ø 95 mm frosted glass disc, black/ white plate and detachable power cord			

	Stereo BMS 11-C-2L	Stereo BMS 11-B-2L	Stereo BMS 11-B-2L Trino	Stereo BMS 140 Bino Zoom, LED	Stereo BMS 143 Trino Zoom, LED
	74950	74952	74954	749555	749575
	✓	✓	✓	✓	✓
	✓	✓	✓	✓	✓
	✓	✓		✓	
			✓		✓
				✓	✓
		✓	✓		
	✓				
	20x and 40x	10x and 30x	10x and 30x	7x to 45x	7x to 45x
	✓	✓	✓	✓	✓
	✓	✓	✓	✓	✓
				✓	✓
	✓	✓	✓		
	✓	✓	✓	✓	✓
	✓	✓	✓	✓	✓



74920 Stereo BMS 130, LED



74940 Stereo zoom BMS 133, LED



74945 Stereo zoom BMS 133, Trino, LED



74950 Stereo BMS 11-C-2L



74952 Stereo BMS 11-B-2L



74954 Stereo BMS 11-B-2L Trino



74955 Stereo BMS 140 Bino Zoom, LED



749575 Stereo BMS 143 Trino Zoom, LED

XL Stereo's Accessories



74996 Universal stand for BMS 11, 130 to 144, movement in X-, Y- and Z-axis

- Extra heavy version
- Table mounting
- Head not included
- Height: 50 cm



74995 Boom stand for BMS 11, 130 to 144, movement in X and Y-axis

- Base dimensions: 230 x 230 mm
- Pillar: Ø 32 x 420 mm
- Horizontal arm: 450 mm
- Head not included

Extra heavy version

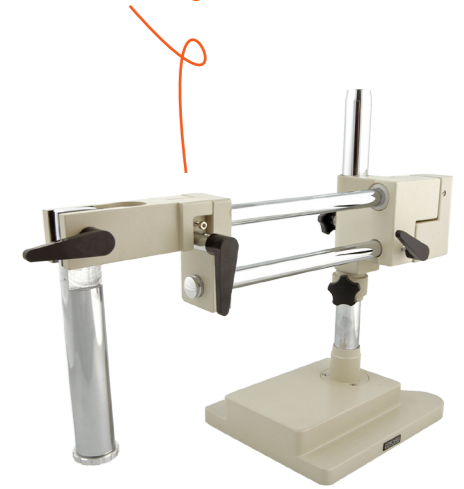

74997 Boom stand for BMS 11, 130 to 144, extra heavy version, movement in X-, Y- and Z-axis

- Base dimensions: 260 x 210 mm
- Pillar: Ø 32 x 420 mm
- Horizontal arm: 550 mm
- Head not included

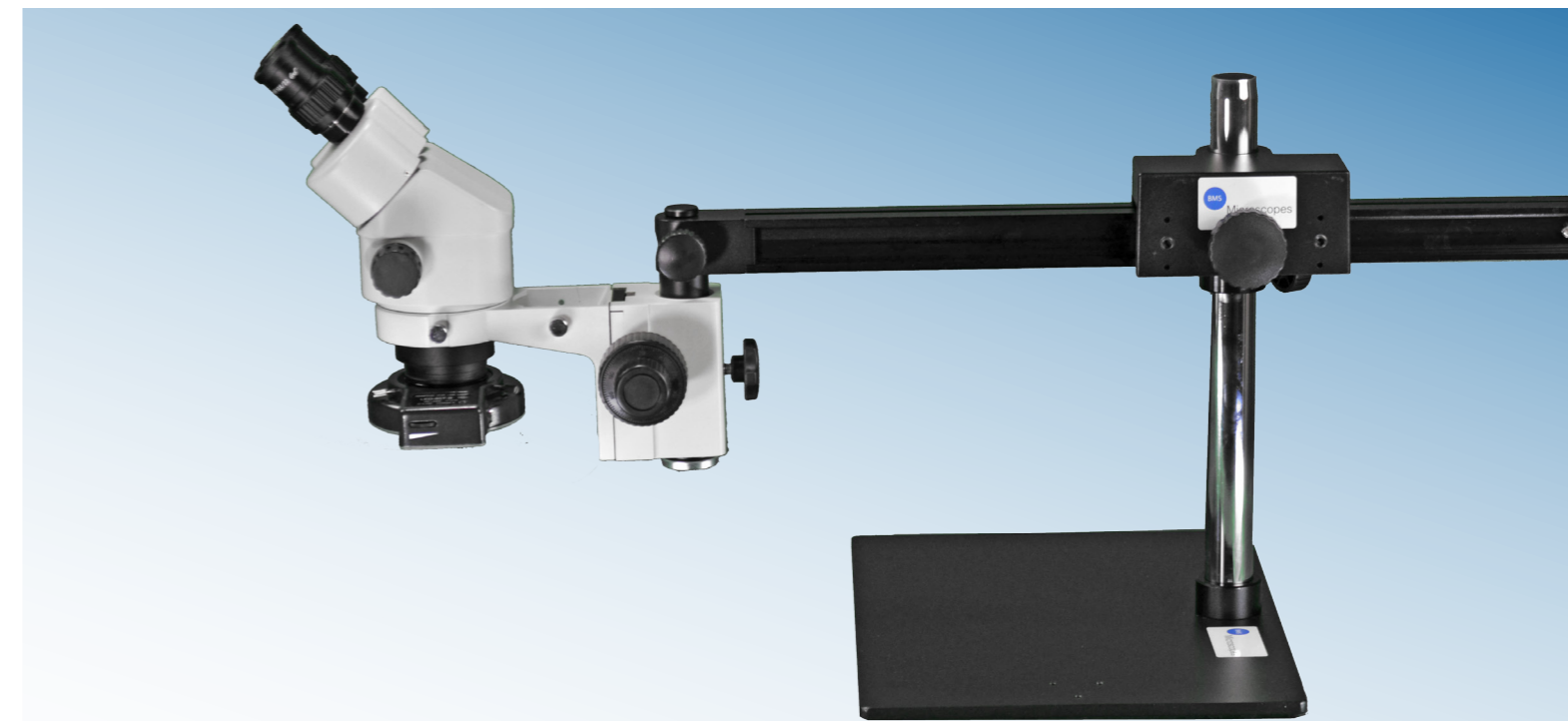

74998 Boom stand for BMS 11, 30 to 144 X- and Y-axis

Movement of arm over a ball bearing system, guarantees smooth and precise movement. Pillar can be attached on short side of base or on the long side. Holds stereo microscope head and carrier from the BMS 130/133 and BMS 140/143 range. Also holds other stereo microscope head carriers with a pillar diameter of 32 mm.

- Length arm: 59 cm
- Base: 28 x 38 cm
- Height of pillar: 35,5 cm
- Diameter pillar: 32 mm



75038 Mechanical stage

- Precision stage with XY
- Adjustment per 0.1 mm
- Dimensions: 160 x 125 x 21 mm
- XY travel range: 75 x 55 mm
- Glass Ø dimension: 90 mm
- Mounting Ø: 95 mm



74960 Polarization set for BMS 140/143 series

- Polarization plate: Ø 95 mm



75060 Height control BMS bino or trino head

- For pillar Ø 32 mm

Item no.	Description
760605	Photo adapter DSLR universal
74965	Dark field device Ø 95 mm
76170	Dark field device for BMS XL series
74960	Polarization set for BMS TS and 141/144 series
7572755	Cold light source LED 24 W
76530	Universal Digitube adapter
76531	Smartphone holder for Digitube
75053	CCD adapter for BMS 144 Trino
74979	CCD adapter for BMS 143 Trino
76029	Storage case, wooden
761435	Specimen holder plate Ø 95 mm, black and white
75035	Mechanical stage coaxial knobs for x- and y-movement
750351	Adapter ring for 75035 on BMS 11 and 14x series
76166	Stage for BMS 20, 30, 40, 11 and 14x series
75034	Mechanical stage
75557	Mechanical stage large for BMS 11 and 140 series
75054	Photo adapter for BMS 144 Trino
75054.1	Eyepiece Pho 4x for BMS 144 photo adapter
76144	Eyepiece WF 5x/18 mm
74982	Eyepiece WF 10x/22 mm BMS 11, 130, 133, 140 & 143
74983	Eyepiece WF 15x/15 mm BMS 11, 130, 133, 140 & 143
74985	Eyepiece WF 20x/10 mm BMS 11, 130, 133, 140 & 143
75030	Eyepiece WF 15x/16 mm BMS 141/144
75032	Eyepiece WF 20x/12 mm BMS 141/144
75820	Eyepiece WF 25x BMS TS series



75052 Storage case aluminum for BMS 141/144

- Dimensions: 520 x 195 x 420 mm



75024 Auxiliary lens 0,5x for BMS 141/144

- Working distance: 177 mm

Item no.	Description
74984	Eyepiece WF 30x/9 mm for BMS 140/144
750376	Eye caps for BMS 130/133
75037	Eye caps
74988	Micrometer eyepiece WF 10x/22 mm
75019	Objective ring without lens, 50 mm
74990	Auxiliary lens 0,5x for BMS 140/143
74991	Auxiliary lens 1,5x for BMS 140/143
74992	Auxiliary lens 2,0x for BMS 140/143
75022	Auxiliary lens 0,3x for BMS 141/144
75023	Auxiliary lens 0,4x for BMS 141/144
75025	Auxiliary lens 0,75x for BMS 141/144
75026	Auxiliary lens 1,5x for BMS 141/144
75027	Auxiliary lens 2,0x for BMS 141/144
749475	Stand BMS 133 with illumination
75055	Stand with illumination
75040	Head binocular BMS 141
75063	Height control with coaxial adjustment
77091	Stage micrometer graticule 10 mm in 0,1 mm
76469	Bulb halogen 6 V/15 W for BMS 140/141
76468	Bulb Tungsten 6 V/6 W for BMS 140
74986	Bulb halogen 12 V/15 W base BMS 11, 140 en 143
74987	Bulb halogen 12 V/15 W top light BMS 11, 140 and 143
9013300155	Top light BMS 130/133 with cable and plug
15543	Lens tissues
75731	Bulb reflector halogen 150 W for 75730 and 757350

749476 Stand BMS XL stereo microscopes with LED illumination

Sturdy and solid base with dual top LED illumination, adjustable, mounted on flexible arms. Top illumination is equipped with high power new generation LED. No bottom illumination.

- Base: 21 x 37 cm
- Height of pillar: 25 cm
- Diameter pillar: 32 mm
- Glass specimen holder plate
- Black and white specimen holder plate (Ø 95 mm)
- Length flexible arm: 38 cm
- Power: 90 - 240 V

Holds XL stereo microscope head and carrier from the BMS 130/133 and BMS 140/143 range. Also holds other XL stereo microscope head carriers with a diameter of 32 mm.



74975 CCD adapter for BMS 11 Trino



75020 Objective ring with lens 0x for BMS 11, 130, 133, 140 and 144



DIGITAL USB CAMERAS

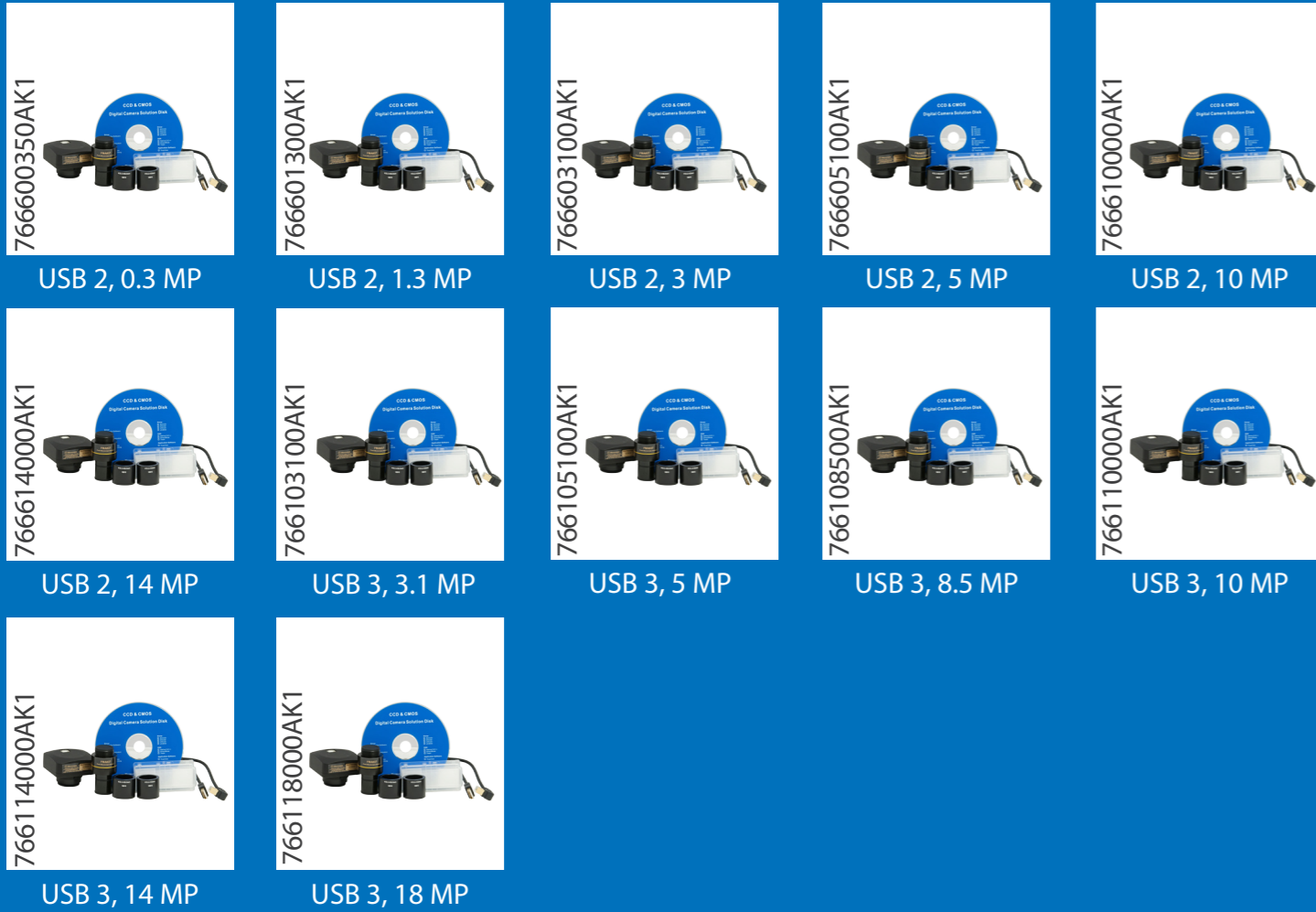

OTHER DIGITAL CAMERAS



DIGITAL HDMI USB CAMERAS



DIGITAL WIFI CAMERAS



Digital cameras	USB2.0, 0.3MP kit	USB2.0, 1.3MP kit	USB2.0, 3MP kit	USB2.0, 5MP kit	USB2.0, 10MP kit		USB2.0, 14MP kit	USB3.0, 3.1MP kit	USB3.0, 5MP kit	USB3.0, 8.5MP kit	USB3.0, 10MP kit	USB3.0, 14MP kit	USB3.0, 18MP kit
Article code	766600350AK1	766601300AK1	766603100AK1	766605100AK1	766610000AK1		766614000AK1	766103100AK1	766105100AK1	766108500AK1	766110000AK1	766114000AK1	766118000AK1
Sensor type CMOS Aptina	✓	✓	✓	✓	✓		✓	✓	✓	✓	✓	✓	✓
Sensor size (mm)	3.58 x 2.69	4.60 x 3.70	6.55 x 4.92	5.70 x 4.28	6.44 x 4.616		6.138 x 4.603	4.505 x 3.38	5.7 x 4.28	5.557 x 4.255	6.44 x 4.616	6.451 x 4.603	6.14 x 4.61
Pixels	0.3 MP	1.3 MP	3 MP	5 MP	10 MP		14 MP	3.1 MP	5 MP	8.5 MP	10 MP	14 MP	18 MP
Resolutions	640 x 480	1280 x 1024	2048 x 1536	2592 x 1944	3584 x 2748		4096 x 3288	2048 x 1534	2560 x 1922	3328 x 2548	3584 x 2746	4096 x 3286	4912 x 3684
Connectivity	USB 2.0	USB 2.0	USB 2.0	USB 2.0	USB 2.0		USB 2.0	USB 3.0	USB 3.0	USB 3.0	USB 3.0	USB 3.0	USB 3.0
Lens-mount: C-mount	✓	✓	✓	✓	✓		✓	✓	✓	✓	✓	✓	✓
Compensating lens	0.37x	0.37x	0.5x	0.5x	0.5x		0.5x						
Power: DC 5 V USB port	✓	✓	✓	✓	✓		✓	✓	✓	✓	✓	✓	✓
Compatible with Windows, Mac OS X, Linux, Android and iOS.	✓	✓	✓	✓	✓		✓	✓	✓	✓	✓	✓	✓

Camera 5MP is also available with WiFi (art. no. 766600720BK1) Please see page 52 for more information.

BMS_pix3 Windows Version

- Live video preview
- Captures still images and video
- Time-lapse capture
- Exposure and white-balance controls
- Dark field correction
- Digital binning
- Image processing
- Measurement tools, including lines, arcs, polygons
- Segmentation and counting tools
- Image-stitching, extended depth-of-field, HDR
- Fluorescence colour-mapping

BMS_pix3 Mac/Linux Versions

- Live video preview
- Captures still images and video
- Exposure control
- Colour adjustment
- Measurement tools, including lines, arcs, polygons

Supported languages

English, German, French, Polish, Turkish, Russian and Japanese

*Fun fact:
The camera body, made from tough zinc alloy, ensures a heavy duty workhorse solution. No moving parts included.*

The camera is designed with a high quality IR-CUT to protect the camera sensor.

In the box you will find:

- Camera
- Software CD with BMS_pix3 and complete manual (English)
- Calibration slide
- Microscope adapters with optics
- Two tube size adapters (23,2 to 30,0 mm and 23,2 to 30,5 mm)
- USB cable





HDMI camera

763696 HDMI camera

Through standard HDMI interface to stream the video to display or HDTV. Easy connecting to other equipment with the C-mount optical interface. High resolution and high frame rate, perfect colour reproduction, highly integrated and compact, low failure rate and stable performance.

- Sensor size: 4.8 x 3.6 mm
- Pixel (µm): 3.75 x 3.75
- FPS/resolution: 30 @ 1080x720
- Exposure: 0.21ms~2000ms
- Lens: C-mount lens
- Cable: HDMI
- Memory card: SD card
- Mouse: USB mouse/USB wireless mouse
- Width x depth x height: 50 x 50 x 61 mm

1. HDMI output port connected to the HDMI diaplayer
2. The blue LED indicator
3. USB mouse
4. Power supply DC 12 V/1 A power adapter
5. SD card slot

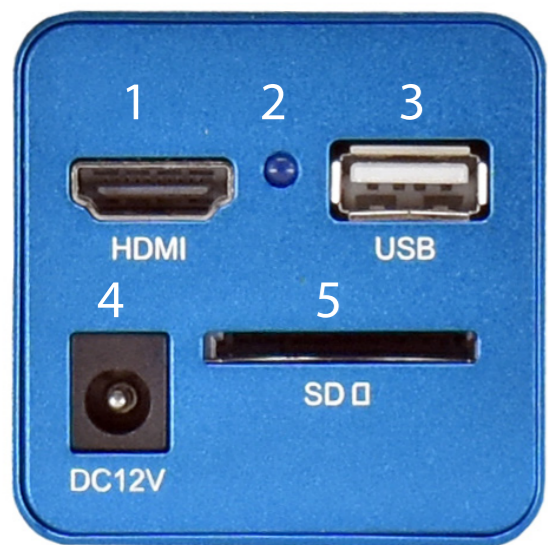

In the box you will find:

- Camera
- Software CD
- Calibration slide
- Microscope adapters with optics
- Two tube size adapters (23,2 to 30,0 mm and 23,2 to 30,5 mm)
- HDMI cable
- USB cable
- SanDisk Ultra SDHC card 16 GB
- Power supply 12 V/1 A DC
- Mouse

HDMI+USB, 2 MP

- C-mount camera with high sensitivity CMOS sensor
- Simultaneous HDMI and USB output
- Built-in mouse control
- Built-in image capture and video record to SD card
- Built-in camera control panel for mouse control
- Built-in toolbar including zoom, mirror, comparison, freeze, cross and browser functions
- Built-in image and video browsing, display and play
- Ultra-Fine colour engine
- With advanced video and image processing application TopView
- Support standard UVC for Windows, Linux and Mac
- The camera can be used for microscope, industrial stereo microscope and online inspection

- Sensor size: 5.5 x 3.4 mm
- Pixel (µm): 2.8 x 2.8
- FPS/resolution: 60 @ 1920x1080
- Exposure: 0.4ms~999ms
- Lens: C-mount lens
- Cable: HDMI
- Memory card: SD card 4 GB or more
- USB camera or USB mouse
- Width x depth x height: 78 x 70 x 92 mm

In the box you will find:

- Camera
- Software CD
- Calibration slide
- Microscope adapters with optics
- Two tube size adapters (23,2 to 30,0 mm and 23,2 to 30,5 mm)
- HDMI cable
- USB cable
- SanDisk Ultra SDHC card 16 GB
- Power supply 12 V/1 A DC
- Mouse



76601080HA Camera, HDMI+USB, 2 MP

AutoFocus version



76601080HAAF AutoFocus camera, HDMI+USB+AF 2 MP SD card

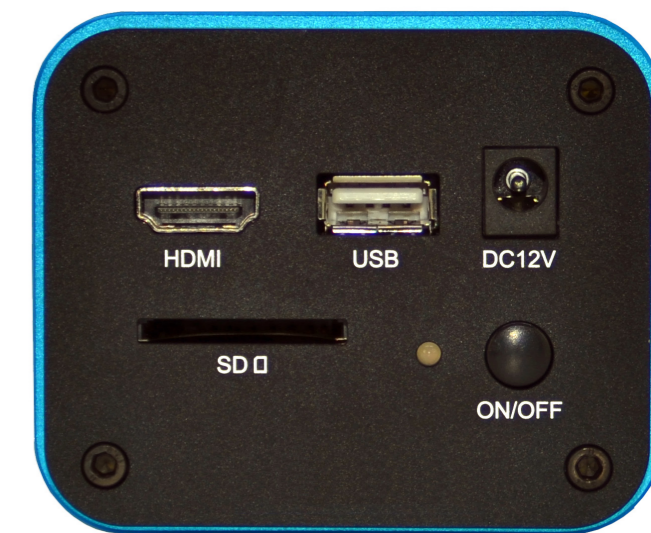

USB 2.0, WiFi, kit



The camera can be connected to a desktop computer or compatible mobile device through WiFi. The USB port is used for power only, drawing from an USB-bus connection, or by using the included USB power adapter. Featuring built-in C-mount compatibility and 23 mm reduction lens adapter. Our camera can be attached to any instrument with a C-mount or a 23 mm, a 30 mm and a 30.5 mm photo port. The camera is equipped with CMOS colour sensor and comes with a high-speed USB 2.0 cord, four mounting sizes (23 mm, 30 mm, 30.5 mm, and C-mount) and instructions.

- Sensor: Aptina MT9P001(C) CMOS (colour)
- Sensor size: 1/2.5" class (5.63 x 3.17 mm)
- Reduction lens: 0.5x
- Max frame rate WiFi: 10fps @ 2592x1944
- Exposure: auto
- ROI white balance/ manual temp-tint adjustment
- Recording system: still picture and movie
- Power supply: DC 5 V over USB port
- Operating system: Windows XP/Vista/7/8/10 (32 & 64 bit), Mac OS X and Linux



766600720BK1 Camera, WiFi, kit,

4K, HDMI+USB, WiFi+RJ45+SD



All in one C-mount 4K camera with high sensitive and ultra high performance Sony CMOS sensor.

Simultaneous HDMI and WiFi output. Mouse control through USB connection. Built-in image capture and video record through SD card. On screen camera control panel by mouse. On screen toolbar with zoom, mirror imaging, freeze, cross and browser functions.

Ultra fine colour engine with perfect colour reproduction capability.

HDMI, RJ45, USB and WiFi are used to transfer the data to either a HDMI display (screen) or to a computer.

For HDMI output: the camera control panel and toolbar are displayed on the HDMI screen. In this case the USB connected mouse can be used to set the camera and control it.

For WiFi output: plug the WiFi adapter in the USB port of the camera. Connect the computer (smartphone or tablet) to the camera and open the BMS_Pix3 App. The camera can now be controlled by the computer through on screen display.

4K



76604K8MPA 4K, HDMI+USB, WiFi+RJ45+SD card

HDMI+USB, WiFi



HDMI and WiFi are used to transfer the data to either a HDMI display (screen) or to a computer. For HDMI output: the camera control panel and toolbar are displayed on the HDMI screen. In this case the USB connected mouse can be used to set the camera and control it. For WiFi output: plug the WiFi adapter in the USB port of the camera. Connect the computer (smartphone or tablet) to the camera and open the BMS_Pix3 App. The camera can now be controlled by the computer through on screen display.

- Sensor size: 5.5 x 3.4 mm
- Pixel (µm): 2.8 x 2.8
- FPS/resolution WiFi: 60 @ 1920x1080
- Exposure: 0.4ms~999ms
- Lens: C-mount lens
- Cable: HDMI
- Memory card: SD card 4 GB or more
- USB camera or USB mouse
- Width x depth x height: 78 x 70 x 92 mm
- Operating system: Windows 7/8/8.1/10 (32 & 64 bit) Mac OS X and Linux



76601080PHB Camera, HDMI+USB, WiFi

CellPad 3, WiFi, HDMI, 5 MP, kit



HDMI and WiFi are used to transfer the data to either a HDMI display (screen) or to a computer. For HDMI output: the camera control panel and toolbar are displayed on the HDMI screen. In this case the USB connected mouse can be used to set the camera and control it. For WiFi output: plug the WiFi adapter in the USB port of the camera. Connect the computer (smartphone or tablet) to the camera and open the BMS_Pix3 App. The camera can now be controlled by the computer through on screen display.

- Sensor size: 5.5 x 3.4 mm
- Pixel (µm): 2.8 x 2.8
- FPS/resolution WiFi: 60@1920x1080
- Exposure: 0.4ms~999ms
- Lens: C-mount lens
- Cable: HDMI
- Memory card: SD card 4 GB or more
- USB camera or USB mouse
- Width x depth x height: 78 x 70 x 92 mm
- Operating system: Windows 7/8/8.1/10 (32 & 64 bit) Mac OS X and Linux



764797 CellPad 3, WiFi, HDMI, 5 MP, kit

BMS SyncCam 12 MP

747085 BMS SyncCam 12 MP

- Total pixel: 12 MP
- Zoom: 10x optical, 10x digital
- Image sensor: 1/4" CMOS
- Lens: f=3.37 mm, F=2.8
- Frame rate: 30 fps (max)
- Shooting area: A3
- Focus: auto/manual
- Output signal: 720 P & 1080p
- Resolution (horizontal): ≥ 900 TV lines
- White balance: auto/manual
- Colour adjustment: red +/- and blue +/-
- Sharpness adjustment: yes
- Brightness adjustment: yes
- Image capture: 1000 images
- Still image resolution: 5 MP, 2 MP & 1080p
- Video recording: one touch on board recording
- Image effect: mirror, rotation, split, freeze, black and white, negative, PIP, title, highlight, mask and mosaic
- PC camera: yes

- TWAIN protocol: yes
- Text mode: yes
- Annotation: on board annotation
- Inputs: VGAX1, HDMIx1, Audiox1 and built-in microphone
- Outputs: VGAX1, HDMIx1, Audiox1
- VGA/HDMI outputs: simultaneously
- USB 2.0: Hostx2, Slavex1
- Internal memory: 4 G
- External memory: USB disk, SDHC card
- Plug & play (USB/SD): yes (Word, PPT, EXCEL, JPG, MP3, MP4, AVI)
- WiFi connection: yes
- LCD screen: no
- USB driver and software: Windows XP/7/8/10 and Mac OS
- Remote control: yes
- WiFi: no
- Wireless projection: optional
- Kensington lock: yes
- LED lighting: arm lightx1
- Power supply: 12 V/2 A
- Weight: 2 kg

In the box you will find:

- SyncCam
- USB cable
- VGA cable
- HDMI cable
- Remote control unit
- Power adapter
- Microscope adapter
- USB stick with software



*Fun facts:
with its extra long
goose neck, the BMS
SyncCam is very flexible.
You can easily position the
camera to the desired spot.*

*The BMS SyncCam makes it
possible to study a variety of
different 3D documents and
objects but also structures and
textures of botanical and
zoological nature at cell
level when connected
to a microscope.*

Surface cam, 2 MP with stand

766502000AS Surface cam, 2 MP with stand

The Surface cam USB digital microscope provides a high-quality and low-cost solution for digital-imaging. Used with a stand or handheld, the microscope provides up to 200x magnification when used with your computer. A simple USB connection is all it takes and the provided software allows you to view real-time video. You can record video files or still images or just watch living material while you explore the microscopic world. Eight built-in LEDs provide light to ensure clear images.

- Total pixel 2 MP
- Oxidized silver aluminum alloy
- Focus knob inherited from the traditional microscope to focus at ease
- Silicon rubber ring to protect the handheld microscope
- Holding screw to hold the microscope
- Stable to ensure capturing the clear video and image
- Overall dimensions: 150 x 80 mm x 135 mm
- Plate dimensions: 150 x 80 mm
- Rack focus with 60 mm range
- Resolutions: 1920 x 1080
- Operating system: Windows (32/64 bit) XP/Vista/7/8/10, Mac OS 10.8+ and Linux kernel 3.13+





766LB050X 0,50x C-mount for Labomed microscope



766MQD42055 0,55x C-mount for Nikon microscope



766N2691500 0,35x C-mount for Olympus microscope



76611541543 0,70x C-mount for Leica microscope

Item no.	Description
76530	Universal Digitube adapter
76531	Smartphone holder for Digitube
76533	Universal TeleEye adapter
76456	BMS microscope 8" TFT screen
76TPHD1080PA	Display with mounting system on HDMI camera
766106011	Calibration slide, M1
766106012	Calibration slide, M2
766106013	Calibration slide, M3
766LB035X	0,35x C-mount for Labomed microscope
766LB065X	0,65x C-mount for Labomed microscope
766LB075X	0,75x C-mount for Labomed microscope
766LB1X	1,00x C-mount for Labomed microscope
766MQD42035	0,35x C-mount for Nikon microscope
766MQD42070	0,70x C-mount for Nikon microscope
766MQD42000	1,00x C-mount for Nikon microscope
766N2691600	0,50x C-mount for Olympus microscope
766N2179000	0,63x C-mount for Olympus microscope
766426114	1,00x C-mount for Zeiss 60N-C microscope
76611541512	0,35x C-mount for Leica microscope
76611541544	0,55x C-mount for Leica microscope
76611541510	1,00x C-mount for Leica microscope
76410	Plug-in adapter C-mount 1/4 inch camera
76420	Plug-in adapter C-mount 1/2 inch camera
766108006	Plug-in adapter 0,50x C-mount camera 1/2 ~ 2/3
766108007	Plug-in adapter 0,75x C-mount camera 1/1,8 ~ 1
766108015	Adapter ring 23,2 to 30,0 mm
766108016	Adapter ring 23,2 to 30,5 mm
766108017	Adapter ring 23,2 to 31,75 mm
747040	Adapter compound and stereo microscope for EcoCam 5 and 8



766037175 1,00x C-mount for Olympus microscope



76645610501 1,00x C-mount for Zeiss 60-C microscope

Item no.	Description
74716	Lens 8 mm for BMS EcoCam
76403	Lens 8 mm for BMS FlexCam
76399	Lens 16 mm C-mount
76401	Lens 25 mm C-mount
75763	Plug-in adapter for Nikon camera
76538	Plug-in adapter for Nikon 5400 camera
76543	Plug-in adapter for Olympus 4040 camera
76537	Plug-in adapter for Olympus 5060 camera
76539	Plug-in adapter for Canon A95 camera
76542	Plug-in adapter for Canon 620 camera
75765	Adapter TS for Sony DSC-W5 camera
76411	Diaview adapter C-mount for camera 1/3 inch
76395	Aluminum case for BMS EcoCam
747035	Power supply EURO for BMS EcoCam 5 & 8
764581	USB 2.0 cable for eyepiece & C-mount camera
7645458	AV cable 3,5 mm jack plug to 3x cinch

76496 Wireless system for video/audio

Wireless 2.4 GHz transmission system in a very compact housing for transmitting audio / video signals. This device is designed to transmit signals from devices such as DVD, SAT, VCR, PC, STEREO, etc. Including infrared extension cable for operating the equipment.

- Frequency band: 2.400 GHz ~ 2.4835 GHz (4 channel)
- Frequency infrared ext.: 433 MHz
- Input transmitter: 1 x RCA video, 2 x RCA audio
- Output receiver: 1 x RCA video, 2 x RCA audio
- Dimensions transmitter: 120 x 88 x 34 mm
- Dimensions receiver: 120 x 88 x 34 mm
- Colour: black
- Including: 2x power supply 9 V/400 mA DC; 2 x Scart/RCA cable; 1 x IR extension cable



76412 Diaview adapter C-mount for camera 1/2 inch



766108005 Plug-in adapter 0,37x C-mount for camera 1/4 ~ 1/3



75761 Adapter TS for Nikon camera



76541 Plug-in adapter for Ricoh Gx8 camera

DIGITAL MICROSCOPES



100-FL-Digi 3 MP



ST-40-C-2L, LED & digitale 3 MP



Zoom143 with USB camera 3 MP LED

100-FL-Digi 3 MP

SPECIFICATIONS MICROSCOPE

- Eyepiece: WF 10x/18 mm with pointer, locked
- Tubes: first tube 45° inclined with eyepiece, second tube 90° with USB 2.0, CMOS 3 MP
- Nosepiece: triple
- Objectives: DIN achromatic 4x, 10x and 40x (spring loaded)
- Focussing mechanism: coarse with slip clutch and fine focussing knobs with slide protection
- Stage: 110 x 120 mm metal plan stage with 2 stage clips
- Condenser: fixed, N.A. 0.65 with built-in iris diaphragm and filter holder
- Illumination: new generation power LED. Light intensity stepless adjustable through rotary potentiometer. Light output comparable with 20 W halogen illumination.
- Lifespan: approx. 50.000 hours
- Magnification: 40x, 100x and 400x. Optional extendable up to 1500x.
- Power supply: 90~240 V/50 Hz. The electric circuit is protected by a fuse. (no option to mount battery in this version)
- Detachable power cord
- Including: dust cover, manual and tension wrench

SPECIFICATIONS CAMERA

- Sensor type: CMOS Aptina
- Sensor size: 6.55 x 4.92 mm
- Pixels: 3 MP
- Resolutions: 2048 x 1536
- Lens-mount: C-mount
- Spectral range: 380-650 nm (with IR-filter)
- ROI white balance/ manual temp-tint adjustment
- Colour rendering technique: ultra fine colour engine
- BMS_pix3, Native C/C++, C#, Directshow, Twain and Labview
- Recording system: still picture and movie
- Compatible with Windows, Mac OS X, Linux, Android and iOS
- CPU: Equal to Intel Core 2 2.8 GHz or higher
- Memory: 2 GB or more
- USB port: USB 2.0 high-speed port
- Display: 17" or larger
- CD-ROM



760235 BMS Microscope 100-FL-Digi 3 MP

BMS ST-40-C-2L digital 3 MP, LED

Built-in digital camera



762585 BMS stereo microscope ST-40-C-2L, LED & digital 3 MP

SPECIFICATIONS MICROSCOPE

- Stand: full metal stand with fixed arm
- Eyepieces: two WF 10x/ 20 mm, locked
- Tube: 45° inclined, one tube with adjustable diopter
- Head: 360° rotatable
- Interpupillary distance: 50 to 76 mm adjustable
- Objectives: 2x and 4x through rotatable turret:
2x: camera will produce an image with diameter of approx. 4.3 mm and the eyepieces an image with diameter of 9.5 mm.
4x: camera will produce an image with diameter of approx. 2.1 mm and the eyepieces an image with diameter of 4.7 mm.
- Optics: anti-fungus treated
- Focussing: coarse focussing knobs with slip clutch
- Incident and/or transmitted LED illumination
- Magnification: 20x and 40x
- Visual range: 10 mm (2x) and 5 mm (4x)
- Working distance: 48 mm
- Base with Ø 95 mm frosted glass and black and white plate with 2 stage clips
- Batteries: 3x AA (optional)
- Connection: 230 V/50 Hz
- Charger: 4.6 V detachable
- Including: dust cover, manual, tension key & eye caps

SPECIFICATIONS CAMERA

- Built-in camera: DSP, 3 MP
- Resolution (horizontal/vertical): 2048 x 1536 pixels
- Pixels: 3.000.000
- Digital output: USB 2.0, cable 1.5 m
- Software: BMS_pix3
- System requirements: Windows W10 and MAC OS

Zoom 143 with USB camera 3 MP, LED

Built-in digital camera



SPECIFICATIONS MICROSCOPE

- Eyepieces: two WF 10x/22 mm with high-eyepoint eyepieces
- Tube: 45° inclined, with dioptic compensation on one tube
- Head: 360° rotatable, with built-in camera
- Interpupillary distance: 50 mm to 76 mm adjustable
- Zoom objective: stepless adjustable 0.7x to 4.5x
- Magnification: 7x to 45x
- Working distance: 108 mm
- Focussing: coarse focussing knobs on both sides with tension control
- Height adjustment by the pole by rack and pinion
- Illumination: incident and/or transmitted adjustable LED illumination
- Power supply: 230 V
- Including: dust cover, manual, eye caps, Ø 95 mm black and white plate, frosted glass plate, software BMS_pix and detachable power cord

SPECIFICATIONS CAMERA

- Camera: 1/2 inch CMOS with DSP/MTF
- Sensitivity (v/lux-sec@550nm): 1.5
- Resolution: 2048 x 1536 pixels
- Pixels: 3.145.000
- Wave length: 400-650 nm
- Dynamic range: 75 dB
- Digital port: USB 2.0, cable ca. 1.90 m
- Operating system: Windows XP, Vista and W 7/8/20

749597 Zoom stereo microscope BMS 143 with USB camera 3 MP, LED

RING LIGHT

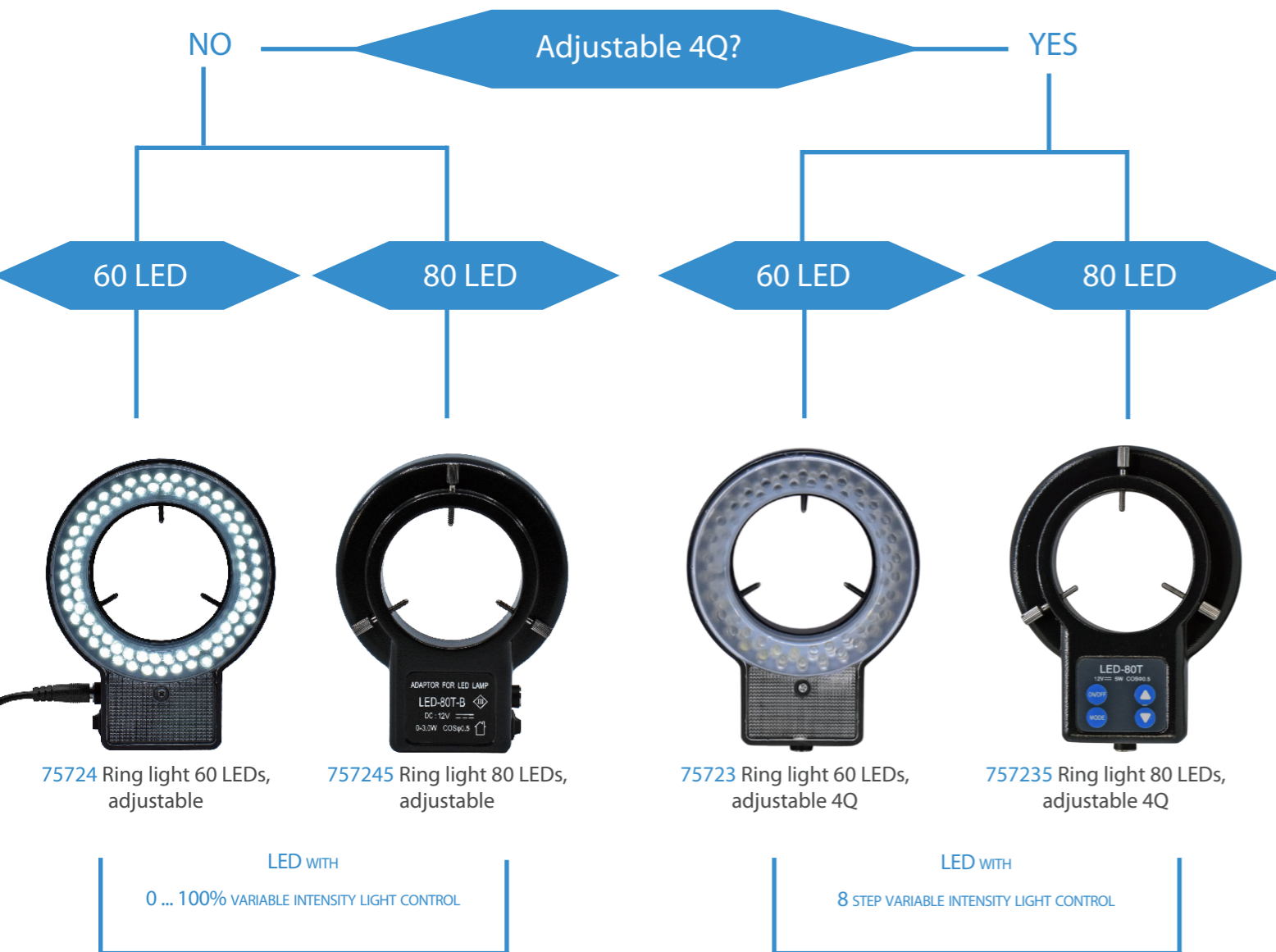

More specifications

- Inner Ø: 60 mm
- Mounting Ø: 45 to 60 mm
- Colour temperature: 6500 K
- Working distance: 50 ... 150 mm
- Input voltage: 12 V DC, 600 mA
- Including EURO power supply 12 V DC/100 ... 240 V AC

Suitable for BMS microscopes series 133, 140 and 143. For the other BMS microscopes, the purchase of adapter ring 75021 is necessary.

FUN FACT:
 60 LEDs = 6500 LUX
 80 LEDs = 8500 LUX

Cold light source LED 24 W

7572755 Cold light source LED 24 W

This light source projects brilliant white light (natural colour). Ideal for temperature critical applications.

Light is transported through a fibre optic system from source to object. Produces no heat near the object. The heat stays in the housing and is transported without mechanical cooling. This LED light source therefore makes no sound.

Includes a double flexible fibre optic light guide with focussing lenses at the end. The light beam can be focussed by the lenses. The gooseneck allows specific positioning of the light beam. Possibility to fit colour filters in the fiberglass holder.

The following colours are available: yellow, green, red and blue.



- Main power : 90~240 V, 50 Hz
- Fuse: T 250 V/5 A
- ESD safe
- RoHS
- CE
- Fiber optics: two-armed with focussing lens
- Colour temperature: 6000~7000 K
- Fiber optics port: 5/8 inch
- Bulb : 24 W LED
- Bulb life: 10.000 hours
- Lamp housing: space-saving
- Including: detachable power cord



757352 Ring light guide for 757350

- Length flexible arm: 830 mm
- Mounting Ø light source: 15 mm
- Mounting Ø opening: 55 mm
- WITHOUT mounting adapter

Objective rings for BMS 11, 130, 133, 140-144

	Ø 50 mm	Ø 55 mm
With lens		75020
Without lens	75019	75021

Cover slips

SQUARE



RECTANGLE



ROUND



	0.09 - 0.13 100 pcs in a box	0.13 - 0.17 100 pcs in a box	0.17 - 0.20 80 pcs in a box
18 x 18 mm	11297	11290	11387
20 x 20 mm		11291	
22 x 22 mm	11298	11292	11388
24 x 24 mm	11299	11293	
21 x 26 mm		11294	
22 x 32 mm		11380	11389
22 x 40 mm		11381	
22 x 50 mm			11391
24 x 50 mm		11296	
22 x 64 mm		11383	
Ø 13 mm	11394	11396	
Ø 16 mm	11395	11397	
Ø 18 mm		11295	
Ø 22 mm		11393	

*Fun facts: all our pure white BMS cover slips are made of glass.
Cover slips with thickness 0.09 - 0.13 and 0.13 - 0.17 are packed per 100 pieces in a box.
Cover slips with thickness 0.17 - 0.20 are packed per 80 pieces in a box.
The cover slips are provided with a plastic box.*

Microscope slides

	76 x 26 mm 1.0 - 1.2 mm thick	75 x 26 mm 1.2 - 1.4 mm thick
Standard	12281	12286
Single frosted	12283	12287
Twin frosted	12288	12289
With single cavity	12290	



12295 Micro life micro slide

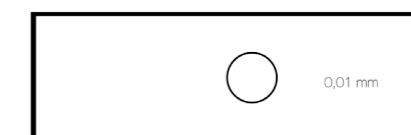

77090 Stage micrometer graticule 1 mm in 0.01 mm



16759 Microscope slide box for 5 slides (size 90 x 32 x 21 mm)



16760 Microscope slide box for 25 slides

- 140 x 100 x 35 mm



16761 Microscope slide box for 50 slides

- 270 x 100 x 35 mm



16762 Microscope slide box for 100 slides

- 270 x 190 x 35 mm



74208	Dissecting set without box
1x	Forceps, straight, blunt, 115 mm
1x	Needle with plastic handle, straight, 135 mm
1x	Spatula with plastic handle, 150 mm
1x	Scalpel with plastic handle, curved, 145 mm
1x	Seeker, 120 mm
1x	Scissors, blunt points, 115 mm
1x	Pipette, plastic



16637	Dissecting set in plastic box
16610	Needle with holder, straight (2x)
16591	Forceps, straight, fine tip, 130 mm
16884	Scissors, straight, sharp 105 mm
16910	Scalpel handle no.4, 110 mm
16911	Scalpel no. 23 steel, lancet-shaped, 5 pcs
16641	Plastic box, stackable, 200 x 60 x 20 mm



166455	Dissecting set in case, 5-parts
16884	Scissors, straight, sharp, 105 mm
16591	Forceps, straight, fine tip, 130 mm
16910	Scalpel handle no.4, 110 mm
16610	Needle with holder, straight
16610	Scalpel no. 23, lancet-shaped, 5 pieces



16640	Dissecting set in case, anatomical
16884	Scissors, straight, sharp points, 105 mm
16883	Scissors, sharp, blunt points, 140 mm
16911	Scalpel No. 23, lancet-shaped, 5 pices (2x)
16581	Forceps, straight, blunt, 130 mm
16630	Double End seeker/ probe
16629	Cartilage knife
16650	Meathooks on chain, 3x
16910	Scalpel handle No. 4, 110 mm
16644	Dissecting case

16642	Dissecting set in case, 9-parts
16610	Needle, straight (2x)
16615	Needle, lancet-shaped
16581	Forceps, straight, blunt, 130 mm
16591	Forceps, straight, fine tip, 130 mm
16884	Scissors, straight, sharp points, 105 mm
16910	Scalpel handle no.4, 110 mm
16911	Scalpel No. 23, lancet-shaped, 5 pieces
17121	Spatula
16644	Dissecting case



16645	Dissecting set in case, 9-parts
16591	Forceps, straight, fine tip, 130 mm
16884	Scissors, straight, sharp points, 105 mm
16885	Scissors, curved, sharp points, 105 mm
16635	Sectioning razor
16910	Scalpel handle no.4, 110 mm
16610	Needle, straight (2x)
16615	Needle, lancet-shaped
16911	Scalpel No. 23, lancet-shaped, 5 pieces
16644	Dissecting case



Fun fact: all parts of the dissection sets are also separately available, except the parts of article code 74208.



16641 Box, plastic (200 x 60 x 20 mm)



16644 Dissecting case (made of synthetic leather) 20 x 31 cm (open)

Forceps

	105 mm	130 mm	145 mm	160 mm	200 mm	300 mm
STRAIGHT & BLUNT	16580	16581		16582	16583	16584
STRAIGHT & FINE TIP	16590	16591	16592			
CURVED & FINE TIP		16596	16597			

STRAIGHT



BLUNT

FINE TIP

CURVED



16598 Forceps, surgical/tissue, 2x3 teeth, 140 mm

16605 Forceps, splinter, 140 mm

16600 Forceps, coverglass, 105 mm

16606 Forceps, galvanic, 90 mm

Needles

	STRAIGHT	LANCET-SHAPED
NO HANDLE	16625	16626
PLASTIC HANDLE	16610	16615
STAINLESS STEEL HANDLE	16609	16614

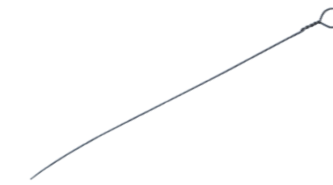

16627 Inoculating loop

- Length: 85 mm
- Ø: 0,5 mm



16620 Needle holder

- For 16625, 16626 and 16627



16611 Seeker/Probe with handle

- Length: 145 mm



16630 Double End seeker/probe

- Length: 130 mm



16616 Insect pins, 100 pieces, no. 00

- 100 pieces
- Stainless steel
- Size no. 00
- Length: 38 mm
- Thickness: 0,30 mm

16618 Insect pins, 100 pieces, no. 4

- 100 pieces
- Stainless steel
- Size no. 4
- Length: 38 mm
- Thickness: 0,55 mm

Scalpels



16629 Cartilage knife



16905 Scalpel stainless, round



16911 Scalpel no. 23 steel, lancet-shaped, 5 pieces

- For 16910 no.4



16912 Scalpel no. 21/24 steel, curved, 5 pieces

- For 16910 no. 4

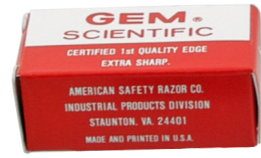

16917 Razor blades with security strip, 5 pieces



16909 Scalpel handle no. 3

- Size: 100 mm

16910 Scalpel handle no. 4

- Size: 110 mm

Scissors



16884 Scissors, straight, sharp points, 105 mm



16885 Scissors curved, sharp points, 105 mm

*Fun fact:
did you know that
all our forceps, needles,
scalpels and scissors are
made of stainless steel?*



16883 Scissors, sharp, blunt points, 140 mm



16886 Scissors paper, 170 mm



16635 Sectioning Razor

- Flat one side, the other being hollow ground



16648 Handmicrotome, cylindrical

- Handmicrotome with table clamp and blade

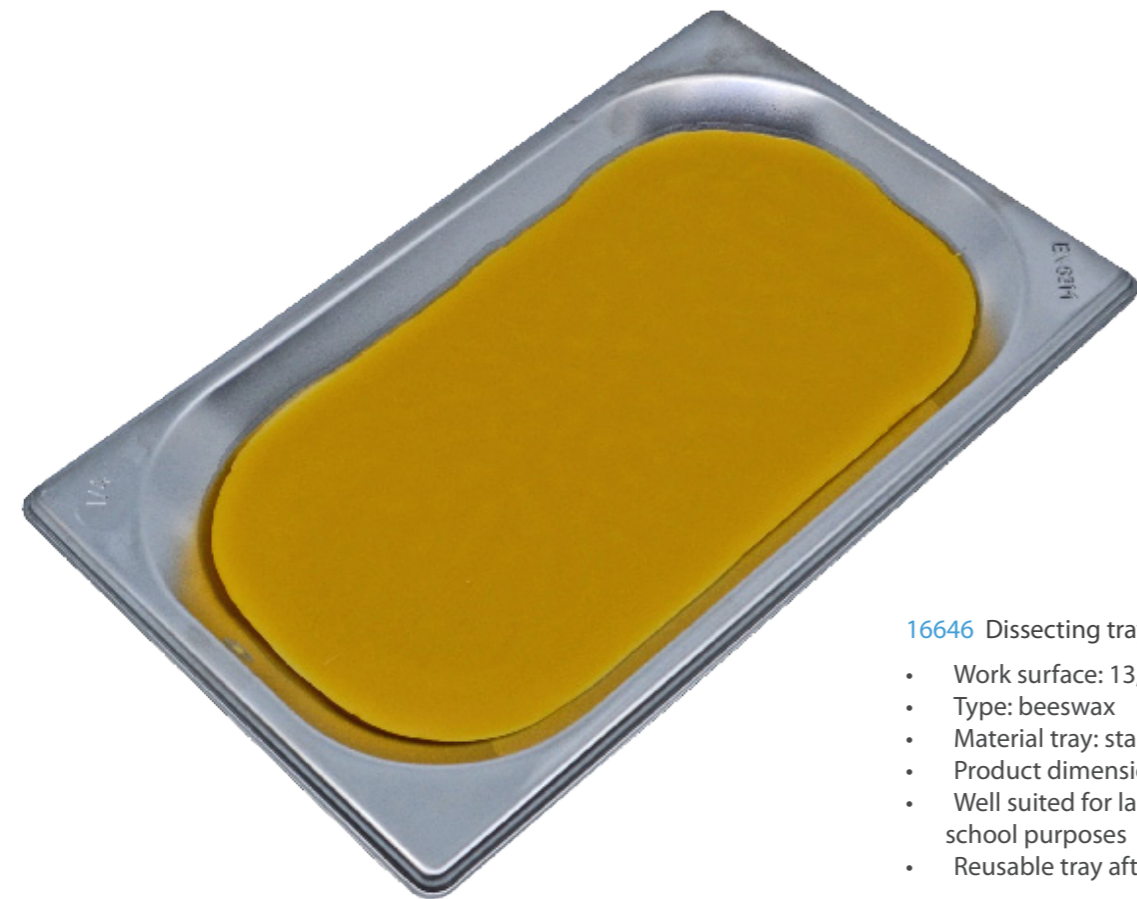

16646 Dissecting tray with wax

- Work surface: 13,5 x 23,7 cm
- Type: beeswax
- Material tray: stainless steel
- Product dimensions: 265 x 162 x 20 mm
- Well suited for laboratory work and school purposes
- Reusable tray after melting the wax



13665 Petri dish 2 compartments, PS

Petri dish with lid. Sterile packed per 20. Available only in original packaging units

- Diameter: 87 mm
- Height: 15 mm
- Compartments: 2



16650 Meat hooks on chain, 3x

Magnifiers

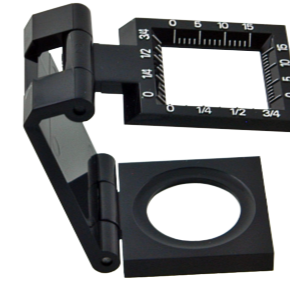

15912 Folding linen tester magnifier

- Lens Ø: 19 mm
- Magnification: 7.5x



15907 Aplanatic hand magnifier

- Lens Ø: 18 mm
- Magnification: 10x



15904 Hand magnifier 3x/ Ø 50 mm

- Lens Ø: 50 mm
- Magnification: 3x



15905 Hand magnifier 3x/ Ø 75 mm

- Lens Ø: 75 mm
- Magnification: 3x



15890 Folding pocket magnifier one lens

- Lens: Ø 22 mm
- Magnification: 4x



15891 Folding pocket magnifier two lenses

- Lens: Ø 22 mm
- Magnification: 4x & 8x



15892 Folding pocket magnifier three lenses

- Lens: Ø 22 mm
- Magnification: 4x, 8x & 12x



15896 Folding pocket magnifier triplet

- Lens: Ø 18 mm
- Magnification: 10x



15902 Magnifying glass on stand 5x/ Ø 75 mm

Clear acrylic base permits ambient light to illuminate subject for clear, bright viewing

- Hands-free observation
- Magnification: 5x
- Housing Ø: 100 mm
- Lens Ø: 75 mm



15900 Stand magnifier 2.5x and 6x/ Ø 90 mm

Permits the use of both hands. Heavy metal base makes this a sturdy magnifier.

- 3-way head
- Lens Ø: 90 mm
- Magnification: 2.5x and 6x
- With LED illumination and batteries



760205 Microscope BMS MS-2

- Eyepiece: WF 10x/18 mm
- Tube: 45° inclined
- Head: 360° rotatable, adjustable in height
- Focussing: coarse focussing knobs with slip clutch
- Objective: locked on, 2x
- Stage: with 2 stage clips
- Including: dust cover, manual and black and white plate, Ø 60 mm



760955 Stereo BMS S-05-L

- Eyepieces: two WF 10x/20 mm
- Tube: 45° inclined
- Objectives: 2x
- Focussing: coarse focussing knobs
- Illumination: incident illumination LED
- Connection: 2 x AA battery
- Including: dust cover, manual, Ø 50 mm white plate and 2x AA batteries



74222 Bug barn kit

Only for use by children over 6 years old.

- Bug barn
- Magnifier
- Ventilated bug viewer with micro ruler
- Creature net with handle
- Forceps



77814 Field trip container with forceps

Only for use by children over 5 years old.

- Container for flora and fauna collection
- Lid contains 3 magnifiers (magnification 5x)
- Grid in base (cm and inch)
- Carrying strap



77817 Nature exploring kit

Ideal for observing insects and bugs. This jar is supplied with air vents enabling creatures to breath.

Only for use by children over 6 years old.

- Bug jar (30 cm) with carrying handle
- Top view magnifying lens
- Hand held magnifier
- Forceps
- Creature net with 2 piece handle



74227 Butterfly garden

Only for use by children over 8 years old. Requires 2x 1,5 V AA batteries (not included).

- Watch the caterpillars grow into butterflies
- Learn about the amazing life cycle of butterflies and how they transform
- The garden works as a living environment and can also be used as a net to catch butterflies
- Include detailed instruction manual with activities



74221 Insect exploring kit

Only for use by children over 5 years old.

- Multilevel ant house
- Ant tunnel
- Ant platform
- Two way bug viewer with handles
- Fully illustrated colour instruction booklet



77807 Two way bug viewer

This two way viewer allows you to view an object from two different angles, top and bottom. Small objects like insects, grass and leaves can be placed in the tray and can be viewed from both angles.

Only for use by children over 5 years old.

- Magnification 4x
- Top and bottom view
- Easy grip handles
- Including: plastic spider



- 74214** Two sections bug viewer
- Magnification: 4x
 - Sizes Ø: 52 x 62 mm
 - Grid: yes
 - Two sections
 - Including: plastic spider

- 74212** Magnifier 3 in 1
- Sizes Ø: 100, 20 and 20 mm
 - Magnification: 2x, 3x & 4x
 - Ø 100 mm: magnification 2x
 - Ø 20 mm: magnification 3x
 - Ø 20 mm: magnification 4x



74204 Set of 6 slides, set 1

The set consists of 6 slides with 18 assorted specimen.

- Slide drinks: cola, coffee and tea
- Slide plastic: PS foam, EVA foam and PE foam
- Slide synthetic fibers: nylon, polyester and acrylic
- Slide grasshopper: leg, abdomen and wing
- Slide medicine: penicillin, aspirin and glucose
- Slide starch: corn, French bean and rice

74205 Set of 6 slides, set 2

The set consists of 6 slides with 18 assorted specimen.

- Slide microfilm: letters, numbers and picture
- Slide natural fibers: cotton, silk and wool
- Slide animals: fish scale, snake scale and bird feather
- Slide algae: laver, green seaweed and kelp
- Slide vitamin: B2, C and D
- Slide mushrooms: wood fungus, stem toadstool and gill mushroom



15915A Pocket scope 30x

Model 2 in 1 with torch. Requires 2x 1,5 V batteries (not included).

- Pocket scope, magnification 30x
- Torch
- Travel case
- Work station
- Bulb replacement tool
- Manual (English)



- 778165** Magnifying bug viewer
- Magnification: 3x
 - Size Ø: 71
 - Grid: yes
 - Two sections
 - Including: plastic spider

- 15903** Magnifier 3x and 6x
- 2 in 1 magnifier
 - Sizes Ø: 60 & 20 mm
 - Magnification: 3x & 6x



- 77812** Bug viewer 2x /4x
- Magnification: 2x & 4x
 - Sizes Ø: 45 & Ø 35 mm
 - Grid: yes
 - Three sections
 - Including: plastic spider

- 15900** Stand magnifier 2.5x and 6x, Ø 90 mm
- 3-way head
 - Size Ø: 90 mm
 - Magnification: 2.5x & 6x
 - With LED illumination & batteries



- 74215** Three section bug viewer, retractable
- Magnification 2x & 3,5x
 - Sizes Ø: 64 x 87 (42) mm
 - Grid: yes
 - Three sections
 - Including: plastic spider

- 15902** Magnifying glass on stand 5x/ Ø 75 mm
- Hands-free observation
 - Magnification: 5x
 - Housing Ø: 100 mm
 - Size Ø: 75 mm



742165 Model of a set of teeth with large toothbrush

Enlarged approx. 2 times, with large toothbrush to demonstrate how to brush one's teeth correctly.

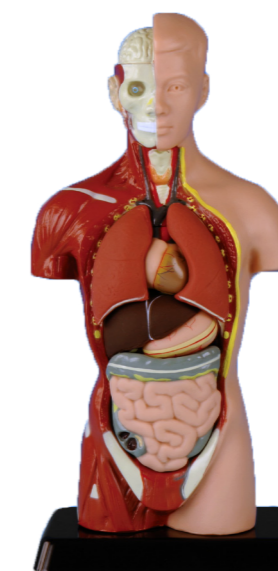

74213 Model Torso, 8 parts

Natural colours. 8 dissectible parts: eye, lung (2x), heart, liver, stomach, intestine and torso (height: 27 cm)



742138 Stethoscope

Just like the one your doctor uses.

BMS Microscopes b.v.
Essebaan 50
2908 LK Capelle aan den IJssel
The Netherlands

+ 31 10 458 42 22
info@bmsmicroscopes.com

www.bmsmicroscopes.com